

REPORT

Cicerostr. 24
D-10709 Berlin
Germany
Tel +49 (0)30 536 53 800
Fax +49 (0)30 536 53 888
www.kompetenz-wasser.d

Pilot Sites for Mitigation of Diffuse Pollution in Ic Amont Catchment (Brittany)

Project: Aquisafe 2

by

Daniel Wicke and Cécile Périllon

Department "Surface Water"

KompetenzZentrum Wasser Berlin gGmbH, Cicerostr. 24, 10709 Berlin, Germany

for

Kompetenzzentrum Wasser Berlin gGmbH

Preparation of this report was financed through funds provided by Veolia



Berlin, Germany

2014

Important Legal Notice

Disclaimer: The information in this publication was considered technically sound by the consensus of persons engaged in the development and approval of the document at the time it was developed. KWB disclaims liability to the full extent for any personal injury, property, or other damages of any nature whatsoever, whether special, indirect, consequential, or compensatory, directly or indirectly resulting from the publication, use of application, or reliance on this document. KWB disclaims and makes no guaranty or warranty, expressed or implied, as to the accuracy or completeness of any information published herein. It is expressly pointed out that the information and results given in this publication may be out of date due to subsequent modifications. In addition, KWB disclaims and makes no warranty that the information in this document will fulfil any of your particular purposes or needs. The disclaimer on hand neither seeks to restrict nor to exclude KWB's liability against all relevant national statutory provisions.

Wichtiger rechtlicher Hinweis

Haftungsausschluss: Die in dieser Publikation bereitgestellte Information wurde zum Zeitpunkt der Erstellung im Konsens mit den bei Entwicklung und Anfertigung des Dokumentes beteiligten Personen als technisch einwandfrei befunden. KWB schließt vollumfänglich die Haftung für jegliche Personen-, Sach- oder sonstige Schäden aus, ungeachtet ob diese speziell, indirekt, nachfolgend oder kompensatorisch, mittelbar oder unmittelbar sind oder direkt oder indirekt von dieser Publikation, einer Anwendung oder dem Vertrauen in dieses Dokument herrühren. KWB übernimmt keine Garantie und macht keine Zusicherungen ausdrücklicher oder stillschweigender Art bezüglich der Richtigkeit oder Vollständigkeit jeglicher Information hierin. Es wird ausdrücklich darauf hingewiesen, dass die in der Publikation gegebenen Informationen und Ergebnisse aufgrund nachfolgender Änderungen nicht mehr aktuell sein können. Weiterhin lehnt KWB die Haftung ab und übernimmt keine Garantie, dass die in diesem Dokument enthaltenen Informationen der Erfüllung Ihrer besonderen Zwecke oder Ansprüche dienlich sind. Mit der vorliegenden Haftungsausschlussklausel wird weder bezweckt, die Haftung der KWB entgegen den einschlägigen nationalen Rechtsvorschriften einzuschränken noch sie in Fällen auszuschließen, in denen ein Ausschluss nach diesen Rechtsvorschriften nicht möglich ist.

Colofon

Present report was developed in compliance with the requirements of the quality management system DIN EN ISO 9001:2008

Title

Pilot Sites for Mitigation of Diffuse Pollution in Ic Amont Catchment (Brittany)

Authors

Daniel Wicke and Cécile Périllon

Quality Assurance

Pascale Rouault (KWB)

Publication / Dissemination approved by technical committee members

Christelle Pagotto (Veolia Water, Technical Direction, Paris, France)

Boris David (Veolia Water, Technical Direction, Paris, France)

Magali Dechesne (VERI, Paris, France)

Emmanuel Soyeux (VERI, Paris, France)

Guy Randon (Veolia Eau Région Ouest, Rennes, France)

Lenore Tedesco (Wetlands Institute, USA)

Norbert Litz (Umweltbundesamt, Berlin, Germany)

Bernard Sautjeau (Setude, St. Malo, France)

Martin Bach (Institute for Landscape Ecology and Resources Management, Justus-Liebig University, Giessen, Germany)

Deliverable number

D 2.2

Abstract

Diffuse nitrate (NO_3^-) contamination from intense agriculture adversely impacts freshwater ecosystems, and can also pose a risk to human health if receiving surface waters are used for drinking water production. Implementation of near-natural mitigation zones such as reactive swales or wetlands have been proven to be promising measures to reduce nitrate loads in agricultural drainage waters. However, the behaviour of these systems at low temperatures and its dependence on system design is not well known until now. In this part of the Aquisafe project, the behaviour of a full scale (length: 45 m) infiltration ditch and two parallel wetlands (surface flow wetland and infiltration wetland) treating drainage water of two agricultural watersheds in Brittany (France) with high nitrate concentrations in the receiving river, were constructed and monitored for 3 flow seasons in 2011, 2012 and 2013 to evaluate field scale performance of these systems. As the flow in both sites is usually restricted to winter and spring months (December – May), systems usually operate at low water temperatures of 5°C - 10°C. Tracer tests revealed shorter than designed retention times (average values for whole flow season 2013: 1.1 h for infiltration ditch, 4.3 h for infiltration wetland and 8.4 h for surface wetland) due to high inflows and preferential flow. This likely is the main reason for observed low average retention of nitrate loads of 1.5-3% during the whole flow season. However, increase of relative nitrate retention to up to 80% during low flow conditions at the end of flow season in May with higher HRT and increasing temperatures show that investigated systems generally work. Results show a stronger correlation between residence time and nitrate reduction for all three systems compared to correlation with temperature. Retention times necessary in existing systems to achieve nitrate retention >30% were 1 day for infiltration ditch and 3 days for wetlands.

Performance was compared to results of two technical scale reactive swales (length: 8 m) operated for 1.5 years at two different residence times (0.4 and 2.5 days), situated at a test site of the German Federal Environmental Agency (UBA) in Berlin (Germany). Similar nitrate reduction was observed for comparable temperature and HRT values (during low flow conditions at end of flow season 2013), showing that up-scaling is a suitable approach to transfer knowledge gathered from technical scale experiments to field conditions. For the design of new mitigation systems, expected inflow volumes have to be investigated carefully in advance to ensure a sufficient residence time for effective nitrate reduction at low temperatures.

Acknowledgements

Cooperation by Caroline Guegain from SMEGA (Pordic, Brittany) as local contact in Brittany is greatly acknowledged, including sampling, sample handling and measurement of standard water quality parameters at both sites. Also, thanks to Thomas Renault, Mathieu Poirrier and Bernard Sautjeau from Setude (former SEEGT) for measurement of flow.

Table of Contents

Abstract	iv
Acknowledgements	v
List of Figures	viii
List of Tables	xi
Chapter 1 Introduction	1
Chapter 2 Pilot sites	2
2.1 Design and monitoring approaches.....	2
2.1.1 Design Criteria.....	2
2.2 Aquisafe Pilot Sites	4
2.2.1 Preparatory studies.....	5
2.2.2 Infiltration ditch	6
2.2.2.1 Placement.....	6
2.2.2.2 Design and components.....	6
2.2.3 Wetlands	10
2.2.3.1 Placement.....	10
2.2.3.2 Design and components.....	10
2.2.4 Flow measurement	14
2.2.5 Water quality monitoring	15
Chapter 3 Site Hydrology	16
3.1 Precipitation pattern	16
3.2 Infiltration ditch	16
3.2.1 Hydraulic Retention Time (HRT)	16
3.2.2 Flow measurements.....	17
3.3 Wetlands.....	19
3.3.1 Hydraulic retention time (HRT).....	19
3.3.2 Flow measurements.....	19
3.4 Hydrology – Summary	21
Chapter 4 Water quality results	22
4.1 Inflow Quality	22
4.1.1 Everyday fluctuations.....	23
4.2 Nitrate retention.....	23

4.2.1 Swale: comparison with UBA data (technical scale swale).....	26
4.2.2 Reduced Loads	26
4.3 Additional water parameters.....	28
Chapter 5 Conclusions and Recommendations	32
5.1 Recommendations for existing systems	32
5.2 Recommendations for new systems.....	33
Appendices	35
Appendix A. Original Sites design	36
Appendix B. Adaptation of original designs	40
Appendix C. Instrumentation	42
Appendix D. Water quality parameters measurements.....	44
Appendix E. Precipitation analysis and resulting storage volume	46
Appendix F. Valves Manipulation in infiltration ditch.....	47
Appendix G. Results tracer tests.....	49
Appendix H. Additional hydrologic results	53
Appendix I. Additional water quality results.....	54
Appendix J. Weekly averages for flow and nitrate reduction	57
Appendix K. Raw Monitoring results.....	60
Bibliography.....	66

List of Figures

<i>Figure 1: Nitrate concentrations in river Ic at Binic in Brittany (river mouth) in 2008/2009</i>	1
<i>Figure 2: Ic catchment in Brittany</i>	2
<i>Figure 3: Subcatchment Ic Amont (Upper Ic) - sites 1 and 6 in were chosen for installation of pilot sites.</i>	4
<i>Figure 4: Plot of topographic data gathered by SMEGA in 2009: (a, left) wetland site; (b, right) ditch site.</i> ..	5
<i>Figure 5: Aerial picture of infiltration ditch (source: www.geoportail.fr, coordinates: 2°55'50"W; 48°32'08"N)</i>	6
<i>Figure 6: Longitudinal section of Infiltration ditch and its monitoring: water level measurements (surrounded in red) and sampling/measuring points (in yellow); comments concerning slopes; Outflow shafts are installed only for monitoring purposes.</i>	7
<i>Figure 7: Cross-section of Infiltration ditch (from Cahier des Prescriptions Techniques, 2011)</i>	7
<i>Figure 8: Open Carbon shaft, SMEGA, 09.09.2011</i>	8
<i>Figure 9: Longitudinal section of the ditch outflow (left) and valve structure (right). When only the upper valve is open, the water level rises up to 10 cm under the filling material surface. When the lower valve is open, the ditch will drain (for testing and maintenance purposes).</i>	9
<i>Figure 10: View of the ditch (towards inflow) with barriers.</i>	9
<i>Figure 11: Schematic view of lower part of swale with outflow shafts (left). Overflow pipe with drain shaft and overflow shaft (right).</i>	9
<i>Figure 12: Aerial picture of wetland site (www.geoportail.fr; coordinates: 2°54'55"W, 48°31' 5,5"N).</i>	10
<i>Figure 13: Wetlands, water level measurement points (surrounded in red) and sampling/measuring points (in yellow)</i>	10
<i>Figure 14: Schematic view of wetland separation chamber and inflow shafts</i>	11
<i>Figure 15: Longitudinal view of infiltration wetland, from AKUT (remark: drains are not represented)</i>	12
<i>Figure 16: Top view of drain control structure in infiltration wetland. Left: initial structure allowing three outflow levels. Right: Modified structure for monitoring season 2013.</i>	12
<i>Figure 17: Longitudinal view of surface wetland (source: Akut Partner).</i>	13
<i>Figure 18: Measurement of outflow in surface wetland</i>	13
<i>Figure 19: Water budget (HRT: Hydraulic Retention Time)</i>	14
<i>Figure 20: Precipitation at weather station in Trémuson, ~5 km from pilot sites</i>	16
<i>Figure 21: Inflow of ditch</i>	17
<i>Figure 22: Results of tracer tests in infiltration ditch with drain valve open (left, inflow: 7.9 m³/h) and closed drain valve (water leaves ditch through overflow pipe) (right, inflow: 6.1 m³/h)</i>	17
<i>Figure 23: Inflow and outflow of infiltration ditch during monitoring season 2013. From 21.2. overflow (E1) equals total outflow due to closed drain valve. Before 21.2., outflow equals sum of D1 (data only from 6.2.13 due to instrumentation problems) and E1 (dark blue line).</i>	18
<i>Figure 24: Inflow and outflow of infiltration wetland during monitoring season 2013. Daily rainfall from Tremuson climate station.</i>	20
<i>Figure 25: Inflow and outflow of surface wetland during monitoring season 2013. Inflow could not be determined manually due to low height of inflow pipe. Daily rainfall from Tremuson station.</i>	20
<i>Figure 26: Hydraulic residence times (HRT) for infiltration ditch and wetlands (from manual flow measurements; for equations defining relationship between flow and HRT see Table 6 in Appendix H).</i>	21

Figure 27: Nitrate concentrations and water temperature in inflow to both sites during monitoring season 2013.....	22
Figure 28: Relative nitrate retention in all three systems during monitoring season 2013 and inflow to wetlands. Upper graph shows daily rainfall at climate station in Tremuson (~ 5km from sites).	23
Figure 29: Relationship between nitrate retention and inflow to the systems (dotted line: 0.5 m ³ /h).	24
Figure 30: Relationship between nitrate retention and hydraulic retention time HRT (regression for ditch (left) does not consider last point at HRT of 5.9).	24
Figure 31: Nitrate retention versus temperature during flow season 2013.	25
Figure 32: Comparison of selected results for nitrate retention in infiltration ditch in Brittany with results of two technical scale swales run at HRT of 0.4d and 2.5d (aged substrate) at UBA as part of the Aquisafe project.	26
Figure 33: Reduced nitrate loads for all three systems during flow season 2013.	27
Figure 34: Nitrate load reductions vs. HRT.	27
Figure 35: DOC inflow concentrations and retention in wetlands and infiltration ditch during flow season 2013 (note: sampling on 11.3. was done during extreme rain event with very high flows).	28
Figure 36: DOC, NH ₄ , NO ₂ and PO ₄ in inflow and outflow of wetlands and infiltration ditch during flow season 2013 (note: sampling on 11.3. was done during extreme rain event with very high flows).	28
Figure 37: Phosphate inflow concentrations and retention in wetlands and infiltration ditch during flow season 2013 (note: sampling on 11.3. was done during extreme rain event with very high flows).	29
Figure 38: pH and oxygen concentrations in inflow and outflow of all systems.	30
Figure 39: Necessary HRT in investigated mitigation systems to reach >30% nitrate retention.	33
Figure 40: Measured conductivity at outlet of C-shaft of infiltration ditch after addition of saturated salt solution to inlet (B1).	49
Figure 41: Measured conductivity at outlet of infiltration ditch after addition of saturated salt solution to inlet (B1) at inflow of 1.1 m ³ /h in May 2013.	49
Figure 42: Measured conductivity at outlet of infiltration wetland (J6) after addition of saturated salt solution to inlet (H6.1) at inflow of 3.1 m ³ /h in February 2013.....	50
Figure 43: Measured conductivity at outlet of infiltration wetland (J6) after addition of saturated salt solution to inlet (H6.1) at inflow of 0.22 m ³ /h in May 2013.....	50
Figure 44: Measured conductivity at outlet of surface wetland (I6.2) after addition of saturated salt solution to inlet (H6.2) at inflow of 2.9 m ³ /h on 21. February 2013. Addition of saturated salt solution resulted in a more pronounced dilution due to the free water body leading to an increase of conductivity by only 15 µS/cm (~250 µS/cm in infiltration wetland).....	51
Figure 45: Water level in infiltration ditch as measured by piezometer at monitoring point C1.2 (black line: water level at overflow, dashed line: water level with open upper drain valve = 10 cm below surface).	53
Figure 46: Comparison of inflow to surface and infiltration wetland. Little differences between mid-December and mid-February are likely due to placement of straw bag into separation chamber in order to increase carbon input into wetlands. Bag was removed in February 2013.	53
Figure 47: Nitrate concentration (in mg-NO ₃ /L) at Ic Amont outlet (IC2) and 10 subcatchments of Ic-Amont. Infiltration ditch is situated in Ica8 and the basins in Ica5, which are relatively extended subcatchments (source: SMEGA).....	54
Figure 48: Everyday inflow fluctuations of NO ₃ of ditch and wetlands during 5 day autosampler campaign.....	54
Figure 49: Nitrate retention during flow season 2011.	54
Figure 50: Linear multi regression plot between nitrate retention (Ret), temperature (Temp) and HRT exemplarily for surface wetland.	55

Figure 51: Total P in inflow and outflow of all systems during flow season 2013.55

Figure 52: Specific conductance in inflow and outflow of all three systems during flow season 2013.....56

Figure 53: Redox potentials in inflow and outflow of all three systems during flow season 2013.56

List of Tables

<i>Table 1: Design criteria for diffuse pollution mitigation systems</i>	<i>3</i>
<i>Table 2: Soil properties, from SEEGT, determined in July 2009.</i>	<i>6</i>
<i>Table 3: Gravel sizes of infiltration layers, ditch (from Cahier des Prescriptions Techniques, 2011)</i>	<i>8</i>
<i>Table 4: Filling layers of infiltration wetland (from design by AKUT)</i>	<i>12</i>
<i>Table 5: Components of water quality monitoring</i>	<i>15</i>
<i>Table 6: Averages and standard deviations of water quality parameters from inflow for both sites for all measured inflows in 2011 and 2013 flow season</i>	<i>22</i>
<i>Table 7: Selected data for inflow, DOC-increase and nitrate retention in C-shaft of infiltration ditch.....</i>	<i>25</i>
<i>Table 8: Summed nitrate loads for whole flow season 2013, calculated from weekly averages. Grey row shows values for hypothetically lower inflow to the ditch similar to wetland inflow.....</i>	<i>27</i>
<i>Table 9: Summary of ranges of parameters relevant for denitrification in investigated systems</i>	<i>30</i>
<i>Table 10: Partial treatment of inflow to the ditch assuming inflow of 4 m³/h and calculated resulting performance towards total nitrate load retention.</i>	<i>32</i>
<i>Table 11: Comparison of needed volume for a retention of 7days (from a table by AKUT), designed volume (by AKUT) and estimated actual volume of water contained during the 2010-2011 season</i>	<i>46</i>
<i>Table 12: Results of tracer experiments and resulting relationships between inflow and HRT.....</i>	<i>52</i>
<i>Table 13: Weekly averages of flow, HRT, relative NO₃-reduction, load reduction and inflow load for infiltration ditch (from 21.2., closure of drain valve, values from ditch outflow E1 were used for determination of weekly averages due to higher accuracy (outflow=inflow).</i>	<i>57</i>
<i>Table 14: Weekly averages of flow, HRT, relative NO₃-reduction, load reduction and inflow load for infiltration wetland.....</i>	<i>58</i>
<i>Table 15: Weekly averages of flow, HRT, relative NO₃-reduction, load reduction and inflow load for surface wetland.....</i>	<i>59</i>
<i>Table 16: Water quality in Infiltration ditch 2011 (see Figure 6 for sampling point names)</i>	<i>60</i>
<i>Table 17: Water quality in wetlands 2011 (see Figure 13 for sampling point names)</i>	<i>61</i>
<i>Table 18: Water quality in Infiltration ditch in 2013; = Under detection limit (DL) = DL/2.....</i>	<i>62</i>
<i>Table 19: Water quality in Wetlands in 2012/13; = Under detection limit (DL) = DL/2 (see Figure 14 for sampling point names)</i>	<i>64</i>

Chapter 1 Introduction

Diffuse nitrate (NO_3^-) and pesticide pollution from intense agriculture adversely impacts freshwater ecosystems, but can also pose a risk to human health if the water is used for drinking water production. In agricultural watersheds affected by diffuse pollution, limitation of fertilizer and pesticide application may not be sufficient to achieve good river water quality. As another strategy to reduce the impact of intense agriculture on watersheds, implementation of near-natural mitigation zones such as reactive swales or wetlands have been proven to be promising measures to reduce nitrate loads in agricultural drainage waters (Périllon and Matzinger, 2010).

After waterworks had to be closed in Brittany due to elevated nitrate concentrations in the river Ic ($> 50 \text{ mg-NO}_3 \text{ L}^{-1}$, see Figure 1), the project *Aquisafe* was initiated. The objective of *Aquisafe* is to reduce pollutant loads (nitrate and pesticides) from agricultural fields by implementation of near-natural mitigation zones at diffuse pollution hotspots at the head of watersheds. Simple and small solutions have to be designed in order to more efficiently reduce nitrate and pesticide concentrations in receiving rivers.

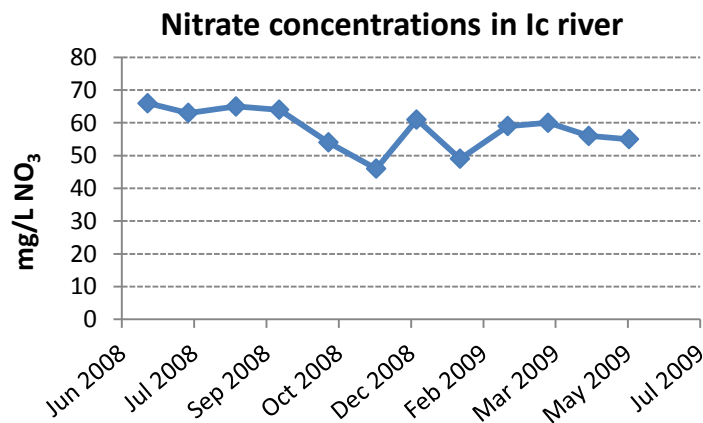

Figure 1: Nitrate concentrations in river Ic at Binic in Brittany (river mouth) in 2008/2009

Objectives of this monitoring are to evaluate simple and small designs regarding their mitigation of nitrate in field scale systems under real conditions (low temperatures due to flow only in winter and spring months). In addition, results should be related to technical scale experiments conducted at the Federal Environmental Agency (UBA) as part of the *Aquisafe* project.

Three constructed wetlands have been implemented and monitored in the Ic Amont catchment, one infiltration ditch (reactive swale with organic substrate layer), and two wetland types (infiltration wetland and surface wetland, operated in parallel). Water flow, nutrients and general water parameters were monitored at all three sites. As the first two monitoring seasons (2011 and 2012) were exceptionally dry years (see 3.1), flow was restricted in all three sites (especially in 2012 flow season, where no sampling was possible), resulting in only few data. However, the monitoring season 2013 was characterized by normal precipitation patterns, and monitoring could be conducted as expected from December 2012 until May 2013.

In this report the design of the pilot sites will be presented together with results of monitoring, mainly from 2012/2013 season. Final conclusions will be drawn for further sites implementation.

Chapter 2 Pilot sites

Potential pilot sites were investigated in the Ic-Amont catchment in Brittany (Figure 2) – a catchment with intensive agriculture resulting in high nitrate concentrations in agricultural drainage waters and receiving surface waters (Ic river, nitrate concentrations in Figure 1). Three systems were realized at two sites: one infiltration ditch and two different wetlands (infiltration wetland and surface wetland) in parallel.

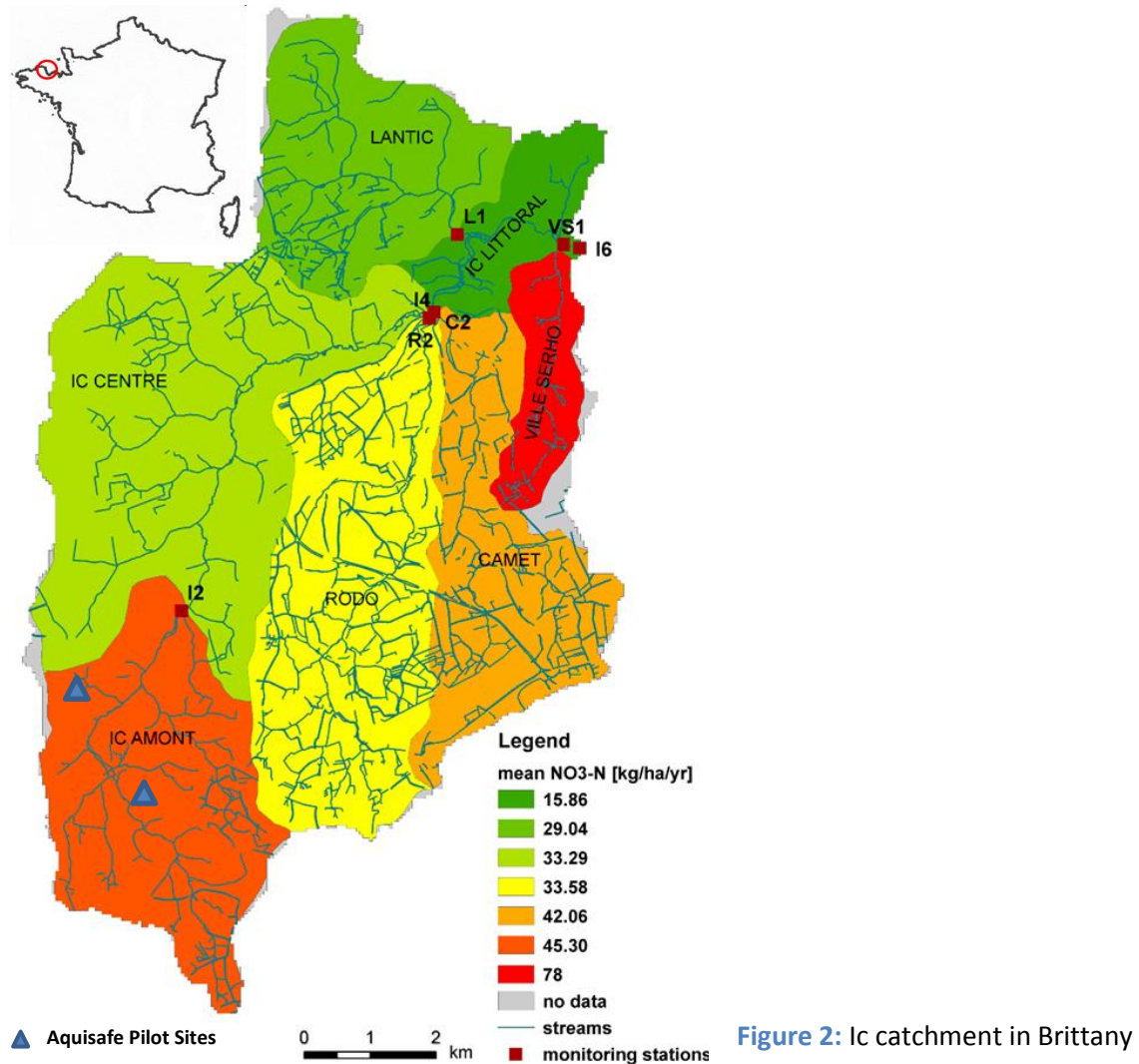

2.1 Design and monitoring approaches

The near-natural treatment systems constructed in the Ic Amont catchment follow the same approach, concerning design and monitoring.

2.1.1 Design Criteria

Wetlands are designed with a main purpose of optimization of nitrate retention, permitting monitoring investigations (sampling points included in system design). A list of design criteria is presented in Table 1. First designs have been done by AKUT Partner based on terrain configuration and first planned monitoring needs; they are presented in Appendix A. Adaptations have been done for the construction; they are shown at the end of Appendix B.

Table 1: Design criteria for diffuse pollution mitigation systems

Condition	Condition that should be fulfilled	To be avoided
Placement	<ul style="list-style-type: none"> - At outlet of a contributive area for nitrate - Agreement with land owner possible - Easy access 	<ul style="list-style-type: none"> - Agricultural fields no longer in production? - Area of intensive exchange between surface and subsurface flow: site hydrology may be difficult to control
Dimension	<ul style="list-style-type: none"> - Dimension that allows Hydraulic Retention Time sufficient for denitrification at prevailing temperatures (however, HRT >1-2 days often not possible) 	<ul style="list-style-type: none"> - System too small for significant nitrate removal
Infiltration Material	<ul style="list-style-type: none"> - High porosity: enables water circulation and storage capacity - Small grain size: high contact exchange area favors exchanges between biofilms (covering gravels) and water - 2/8mm gravel seems a good compromise. 	<ul style="list-style-type: none"> - Material containing too much fine particles (e.g. clay, silt) or possibly reacting material (may cause clogging)
Level control	<ul style="list-style-type: none"> - Emergency spillway or overflow must be planned 	
Carbon addition	<ul style="list-style-type: none"> - Planting of native species of macrophytes - Grass mowing may be useful - Addition of Carbon sources (straw, bark mulch...) as substrate in system 	<ul style="list-style-type: none"> - Growing of trees: possible construction damages by roots - Removal of vegetation from the sites: nutrient budget not possible; they could be a source of carbon
Slope	<ul style="list-style-type: none"> - Enough elevation difference between site inflow and outflow (for simple systems, at least 30cm) - Slight slope for pipes and drain: no stagnation or back-flow 	<ul style="list-style-type: none"> - Use of pumps: added price and maintenance requirements - Large slopes (>3%) of wetland or ditch bottom (loss of volume and retention time) - Water stagnation after the site outflow: downstream bottom level may have to be decreased
Material/Site protection, isolation	<ul style="list-style-type: none"> - Owner can ask to add barriers around site - Protection or securing of sensors and weirs (even in closed shafts) and choice of inedible material to avoid damage by animals - Grids may be installed in inflow pipes to exclude large materials (leaves, branches...) and animals 	<ul style="list-style-type: none"> - Excess textiles within infiltration system layers - Exchanges with subsurface water (leakage to groundwater or groundwater inflow to system). If soil is permeable, an impermeable layer (e.g. clay) should be added at site bottom. - Clogging of inflow grids: they should be regularly cleared
Sedimentation	<ul style="list-style-type: none"> - In case of high particle load in inflow: additional sedimentation shaft or pond at inflow to prevent clogging 	

2.2 Aquisafe Pilot Sites

Ic catchment (92km² coastal catchment situated in Brittany, France) was chosen as one of the Aquisafe study watersheds because of its nitrate concentration frequently exceeding the European threshold of 50 mg-NO₃/L (see Figure 1).

Ic Amont (Upper Ic) had been identified as one of the most contributive sub-watershed of Ic catchment for nitrate contaminations, after river water quality monitoring by SMEGA (bi-weekly sampling and analysis for nitrate since 2008 on 11 points in Ic Amont; for results see Figure 47 in Appendix I). Seven locations (Figure 3) were investigated for their suitability, of which site 1 (ditch) and 6 (wetlands) were chosen as agreement by land owners and access situation were favorable.

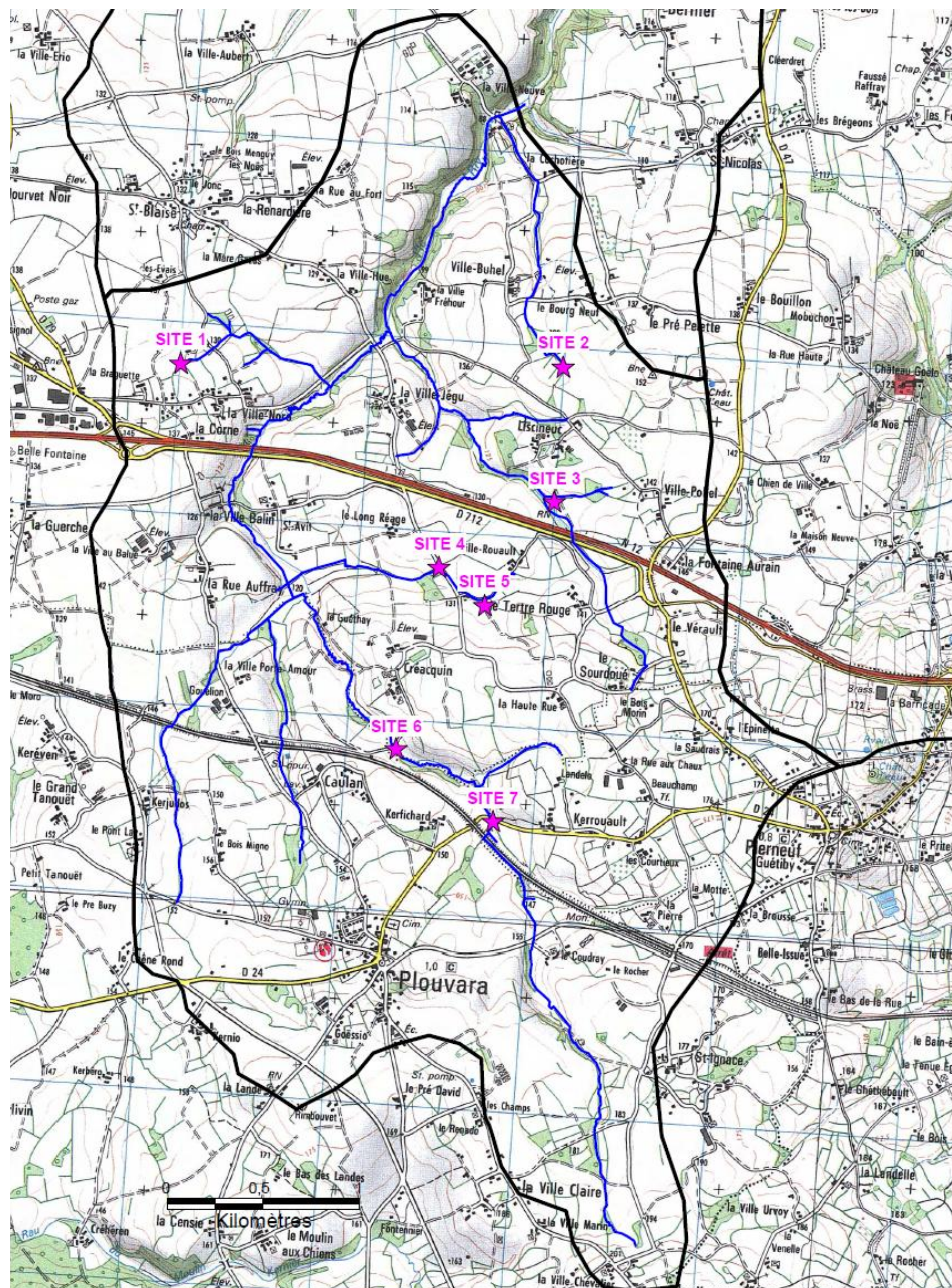

Figure 3: Subcatchment Ic Amont (Upper Ic) - sites 1 and 6 in were chosen for installation of pilot sites.

2.2.1 Preparatory studies

Before design of the wetlands were chosen, some preparatory studies were conducted in Ic Amont watershed. However, they were limited because of time restrictions.

Topography: for design purposes (overall site slope)

For both sites, elevation has been measured by SMEGA every 10 meters (Figure 4). Whereas wetlands were planned on the flat section between field and river (point 2-4 in Figure 4a), topography of site 1 (ditch) revealed that only the middle part of investigated terrain was suitable for installation of the ditch (point 5-9 in Figure 4b).

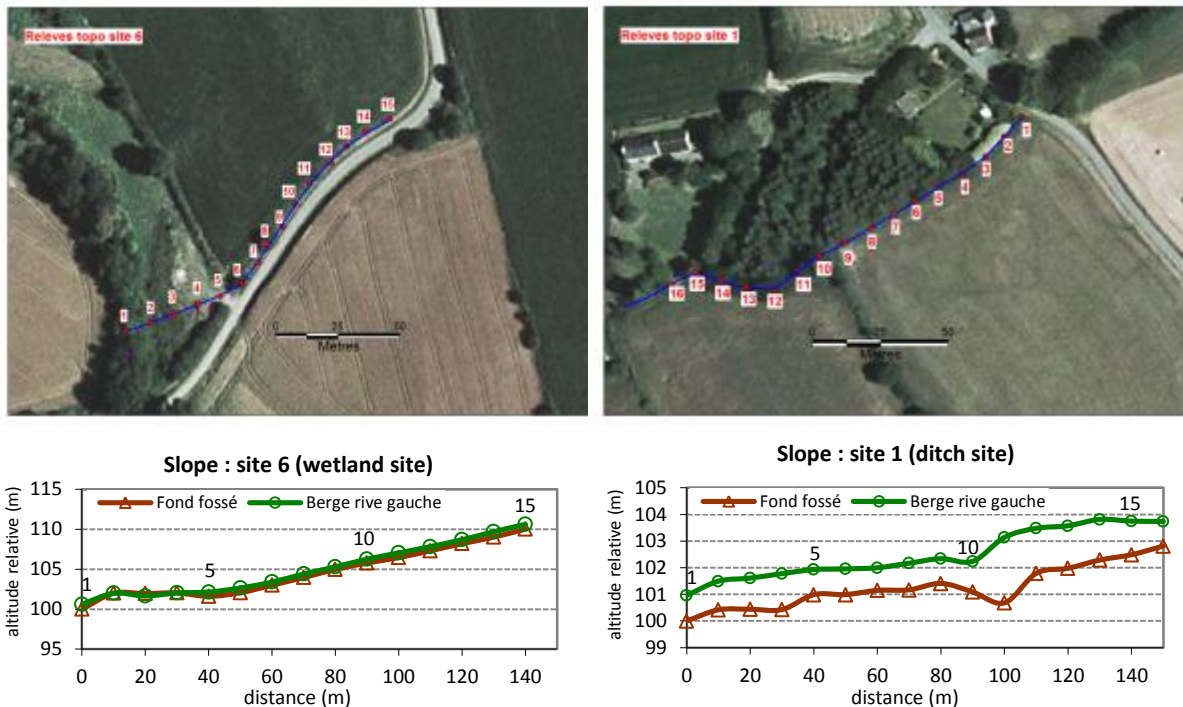

Figure 4: Plot of topographic data gathered by SMEGA in 2009: (a, left) wetland site; (b, right) ditch site.

Hydrology: for design purpose (wetland volume)

For design purposes, AKUT used regional weather data (see calculation explained in Appendix E). Due to absence of available data on existing drainage systems, it was not possible to get accurate data about catchment size only with topography data.

Streams chosen as inflow were known (by SMEGA) to usually flow part of the year, usually from December until April/May; however, inflow volumes were not known. In order to design sites adequately more information about inflow should be collected (for example through 1-year flow measures) before design.

Infiltration test and soil characteristics (need for impervious layer)

An infiltration test has been conducted on both sites (1 or 2 points per site) and top soil texture was described (Table 2). As in site 6 (wetland sites) the soil was identified as compacted and impervious, the bottom of wetlands did not have to be protected with clay. In site 1 the soil was separated from the swale with a geotextile.

Table 2: Soil properties, from SEEGT, determined in July 2009.

Site		Infiltrated volume	k (mm/h)	Soil characteristics (french denominations)
Site 1		700 ml	48	Silty clay soil
Site 6	1-backfilled area	0 ml	0	Both parcels have the same texture (silty-clay). Result difference can be explained by : macroporosity in forest zone (worm galleries, roots) and probably compacted soil in the backfilled area (flat)
	2-forested zone	1 500 ml	102	

2.2.2 Infiltration ditch

2.2.2.1 Placement

Site 1, where the infiltration ditch has been built, is located east of Châtelaudren and about 15 km west of Saint-Brieux, France (Figure 3), where agreement with the land owners was possible. It was constructed in a former drainage swale beside an agricultural field (Figure 5) and has an estimated catchment size of 8.5 ha.

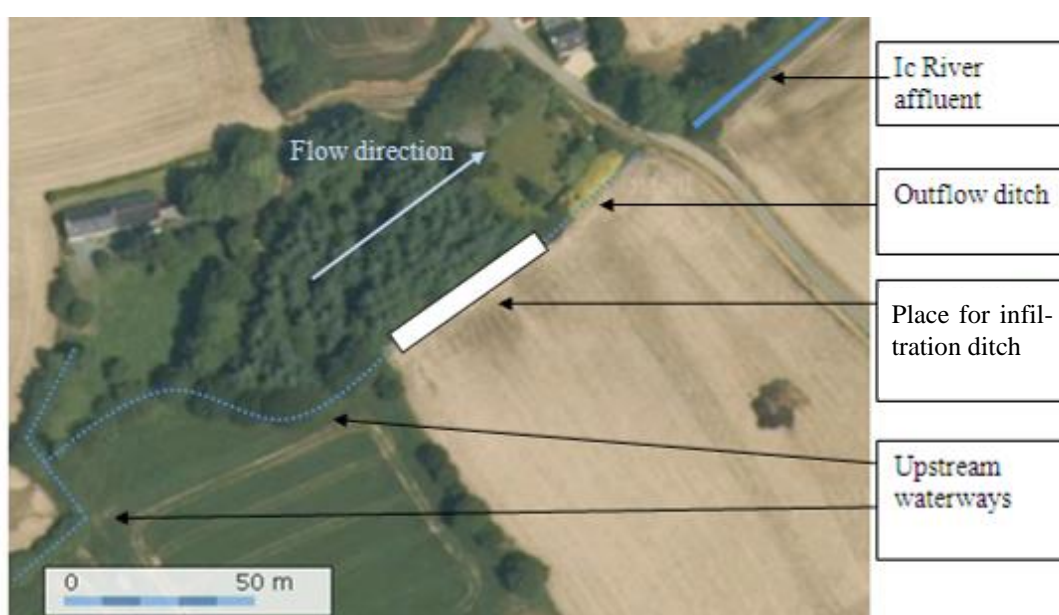

Figure 5: Aerial picture of infiltration ditch (source: www.geoportail.fr, coordinates: 2°55'50''W; 48°32'08''N)

2.2.2.2 Design and components

A schematic view of structures belonging to the infiltration ditch including sampling and flow/water level measurement points is shown in Figure 6. More detailed original design plans can be found in Appendix A. Adaptations to design are summarized in Appendix B.

Denitrification of inflowing water is enabled through 2 steps:

- 1) Sedimentation and enrichment of carbon in the C shaft
- 2) Slow flow through infiltration/substrate layers in an anoxic environment in the ditch

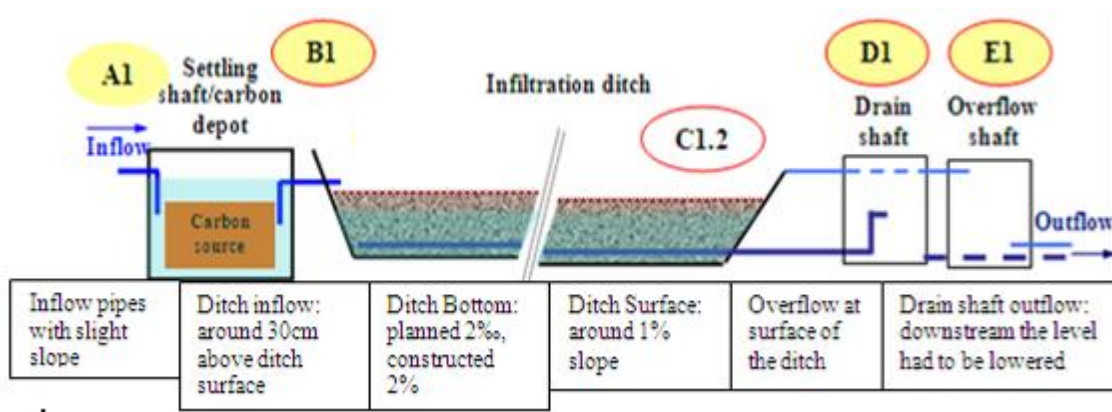

Figure 6: Longitudinal section of Infiltration ditch and its monitoring: water level measurements (surrounded in red) and sampling/measuring points (in yellow); comments concerning slopes; Outflow shafts are installed only for monitoring purposes.

In order to retain 90% of stronger rain-events for a period of 7 days, needed storage volume should be around 2600m³. Calculations are explained in Appendix E.

However, the actual volume is limited by:

- available land: a narrow space at an existing ditch was available for construction
- existing slope: construction should not cause water stagnation upstream or downstream of the site.

A 45 m long, 2 m wide and 1.3 m deep infiltration ditch could be realized at the chosen location. The ditch is unplanted. Filter material and layer design (cross section) can be seen in Table 3 and Figure 7. Water volume was determined after construction in a filling experiment to be 12.9 m³ at highest saturation level (overflow) and 8.7 m³ at drain outflow level with upper drain valve open (see Appendix F). A picture of the swale is shown in Figure 10.

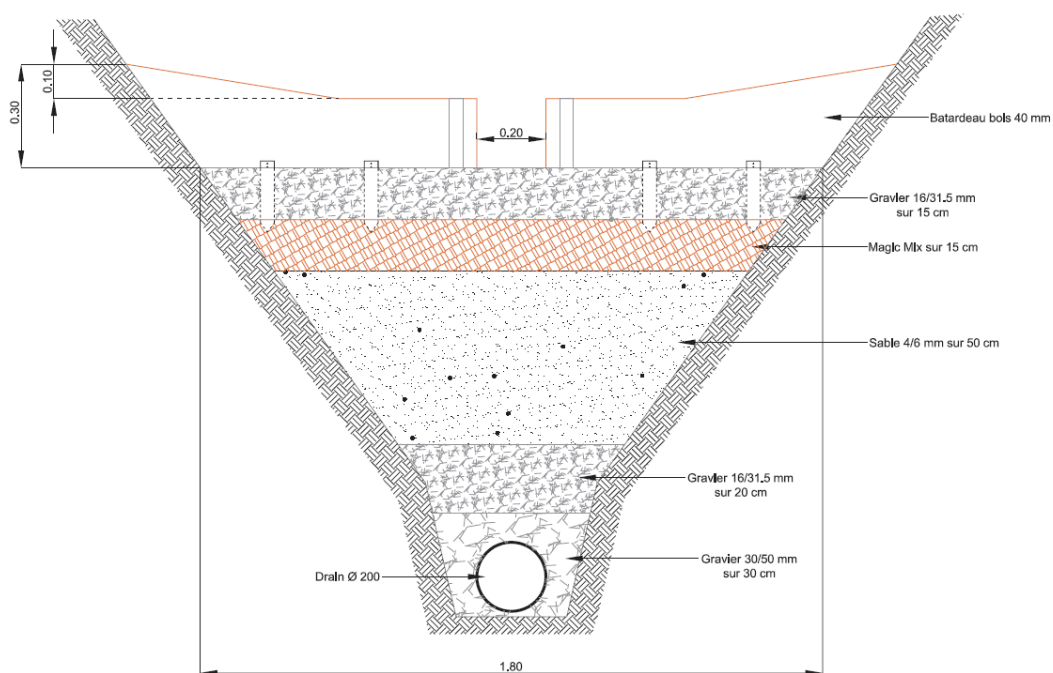

Figure 7: Cross-section of Infiltration ditch (from Cahier des Prescriptions Techniques, 2011)

Table 3: Gravel sizes of infiltration layers, ditch (from Cahier des Prescriptions Techniques, 2011)

	Gravel size (mm)	Depth (cm)	Role
Gravel	16/31,5	15	stabilization of C-rich substrate
Wood chips	20-50	15	Carbon addition*
Coarse sand	4/6	50	Main filling
Gravel	16/31,5	20	Intermediate layer**
Coarse gravels	30/50	30	Drain protection

* The layer of wood chips constitutes a source of carbon, even more when part of it is within saturated volume (in saturated condition, see later)

** Intermediate layers added that should respect filter conditions: $5d_{15} < D_{15} < 5d_{85}$ (d: characteristic dimension of the finer material, D: for coarser material; associated number is the % of mass retained through sieving).

Characteristic values of sizing: Specific length: 5.3 m/ha, Specific surface area: 15 m²/ha

Carbon shaft

Before the inflow of infiltration ditch, water passes through a shaft that contains a cage filled with dispersed straw (Figure 8). The contact time (see 3.2.1) should enable enrichment of in-flowing water with dissolved organic carbon (DOC) at a point that is relatively easy to access for substrate replacement. Potential preferential flow of the inflowing water around the cage (path of least hydraulic resistance) was reduced during monitoring season 2012/13 by placement of canvas bags (filled with fresh straw) in the opening on the left side of the cage.



Figure 8: Open Carbon shaft, SMEGA, 09.09.2011

Water level control structure

In the drain shaft two valves are installed that can be used to control the water level in the swale (Figure 9). For normal operation, the lower valve is closed (for saturation purposes) and upper valve is partly open (in order to avoid overflows), resulting in a water level of 0.72 m. In addition, an overflow pipe is installed (water level ~ 20 cm above level when upper drain valve is open; water level in ditch = 0.91 m), discharging into the overflow shaft, where flow can be measured.

These valves were installed for this experiment in order to enable water level variations within the system. They are not needed for a “normal” infiltration ditch.

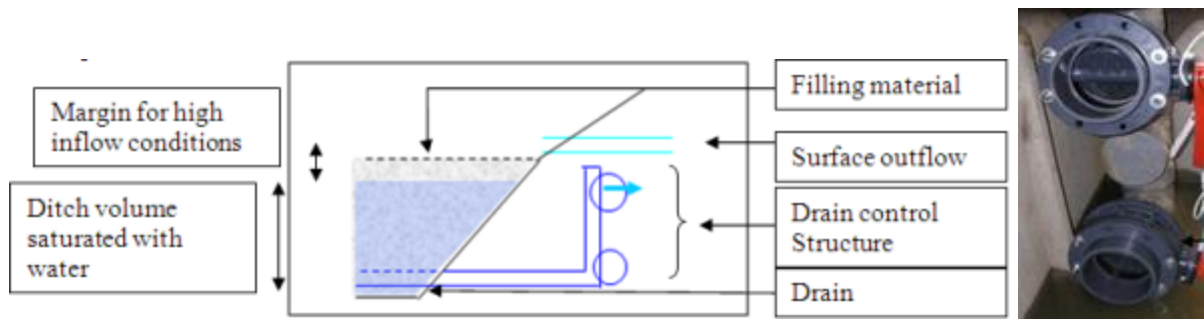

Figure 9: Longitudinal section of the ditch outflow (left) and valve structure (right). When only the upper valve is open, the water level rises up to 10 cm under the filling material surface. When the lower valve is open, the ditch will drain (for testing and maintenance purposes).

Further surface water retention

Three barriers were added at the surface of the ditch in order to retain and then infiltrate more water when inflow is in excess of infiltration capacity (Figure 10). However, as seen during monitoring season 2012/13, water infiltrates very quickly at point of inflow during average inflow conditions (5-15 m³/h). Therefore, barriers can only have an effect at very high flows. Nevertheless, at swales with lower infiltration velocity, barriers can contribute to an increased infiltration volume.



Figure 10: View of the ditch (towards inflow) with barriers.

Outflow shafts (for monitoring purposes)

Two concrete shafts with manholes were installed at the outlet of the swale: while the drain shaft is connected to the drainage pipe of the swale, the overflow shaft receives water from the overflow pipe when water level is ~ 10-15 cm above drainage valve (Figure 11).

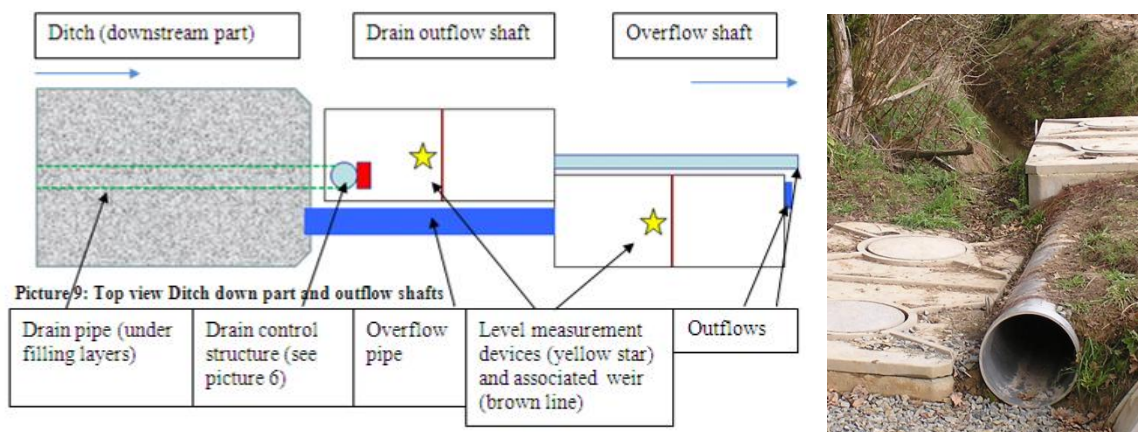

Figure 11: Schematic view of lower part of swale with outflow shafts (left). Overflow pipe with drain shaft and overflow shaft (right).

Due to reduced retention times caused by preferential flow, the drainage valve (see water level control structure) was closed on 20.2.2013 so all water exits the swale through the overflow pipe which resulted in a considerably increased retention time (see also 3.2).

2.2.3 Wetlands

2.2.3.1 Placement

Site 6, where two parallel wetlands were constructed, is located north of Plouvara (Brittany), about 15 km west of Saint-Brieux, France (Figure 3). This location (shown in Figure 12) was chosen because a sufficient-sized flat area was available and the owner was interested in the experiment. The site receives water from field drains as well as road and farm runoff and has an estimated catchment size of 6 ha.

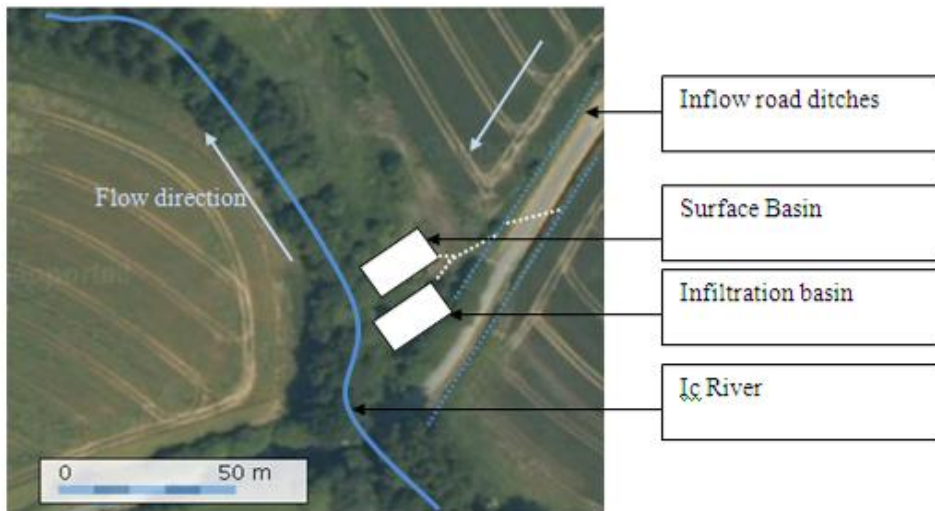

Figure 12: Aerial picture of wetland site (www.geoportail.fr; coordinates: 2°54'55"W, 48°31' 5,5"N).

2.2.3.2 Design and components

At this pilot site, two wetlands were constructed in spring 2010: one subsurface flow wetland (or infiltration wetland) and one surface flow wetland. A schematic view of site layout including sampling and flow/water level measurement points is shown in Figure 13.

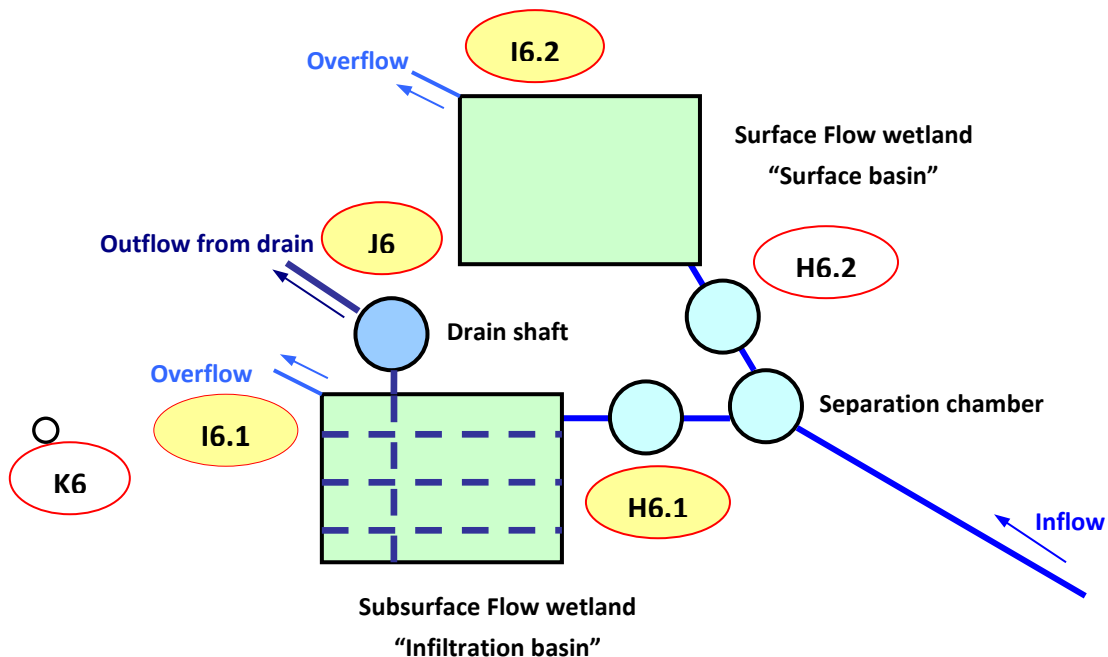

Figure 13: Wetlands, water level measurement points (surrounded in red) and sampling/measuring points (in yellow)

Principle and monitoring points

To enable efficiency comparison between both wetlands, following characteristics are common:

- Inflow: equal distribution of inflows through adjustments of weirs in wetland inflow shafts (H6.1 and H6.2). Only one sample was taken representing inflow of both wetlands
- Surface area of each wetland: 20m*10m
- Carbon source: a mix of native soil, gravel and carbon-rich material (comparable to compost) is located in the surface layer of the infiltration basin and the embankments of the surface basin
- Vegetation: in 2010, both wetlands were planted with *Phragmites* sp. and then left for colonization by other plants. In the surface wetland, plants should result in prolongation of residence time by reducing flow velocity and decreasing preferential flows.

Calculated needed saturated volume for both wetlands for an HRT of 7 days is 1840 m³ (see appendix 5). It had to be reduced to the actual volume (~ 108 m³ for both wetlands, see below) mostly due to restricted availability of land, resulting in a theoretical residence time of ~10 h (see 3.3.1 for experimentally determined values of residence time using tracer tests).

Characteristic values of sizing: Specific surface area (both wetlands): 67 m²/ha

Separation chamber and inflow shafts

Both wetlands received the same inflow that was diverted in the separation chamber. Equal distribution of inflows was achieved through adjustments of the two weirs installed in the inflow shafts (see Figure 14 and Figure 46 in Appendix H). Flow was measured by “Setude” by measurement of water levels in the inflow shafts at the carefully sealed weirs with a defined triangular opening. As sensors were installed in the closed shafts (accessible through manholes), no problems with growing plants occurred. However, due to leaking problems and animal damage to the weirs, flow could not be determined during flow season 2011 and 2012. After problems were fixed before flow season 2013, reliable flow data was determined from December 2012 until May 2013 (see 3.3.2).

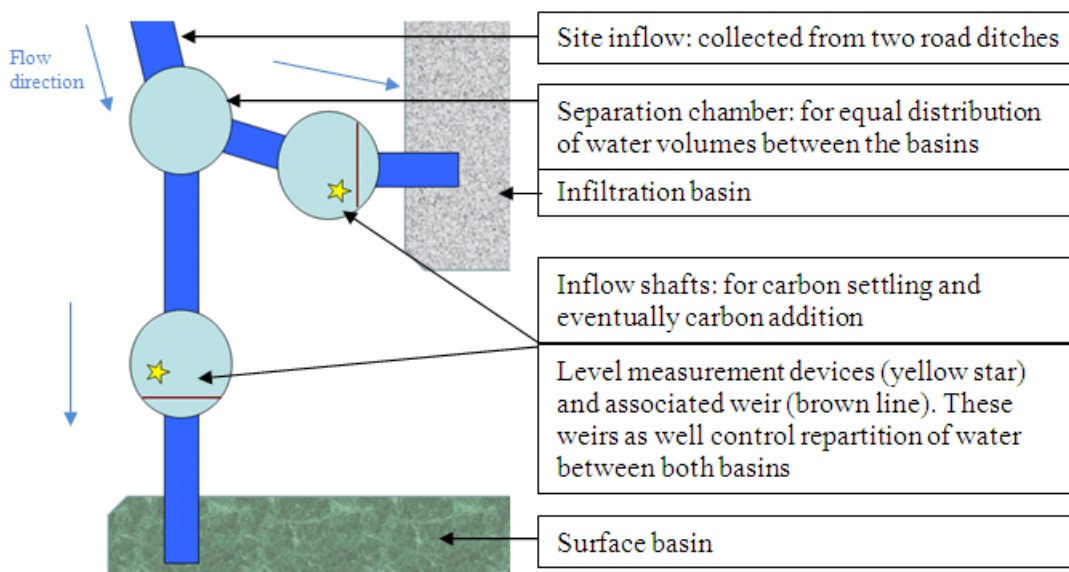

Figure 14: Schematic view of wetland separation chamber and inflow shafts.

Infiltration wetland design

Cross section and filter material of the infiltration wetland are shown in Figure 15 and Table 4. The succession of layers is comparable to the infiltration ditch; however, different organic substrate was used – in the swale wood chips were applied instead of carbon enriched soil). Macrophytes planted during construction were rapidly naturally replaced. More detailed design plans and adaptations to original design can be found in Appendix A and Appendix B.

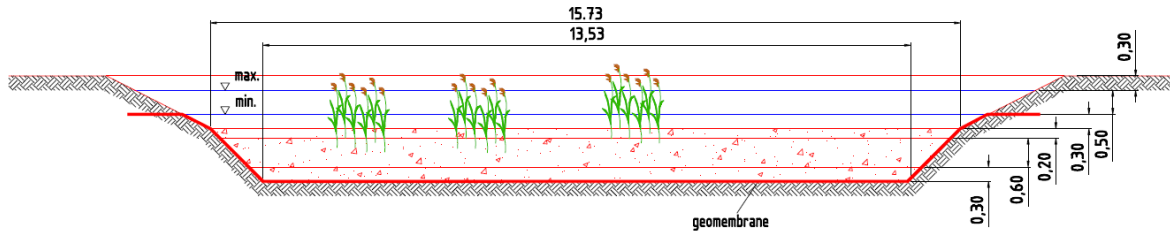

Figure 15: Longitudinal view of infiltration wetland, from AKUT (remark: drains are not represented)

With an estimated 30% pore volume and 1.2 m depth filling material, saturated volume is around 48 m³ (at saturation, water level is next to the surface).

Table 4: Filling layers of infiltration wetland (from design by AKUT)

	Depth (cm)	Role
Amended soil *	20	Carbon and support for plants
Coarse sand	60	Main filling
Gravel	10	Intermediate layer
Coarse gravels	30	Drain protection
Geomembrane		Isolation

* The top layer is composed of gravel, local soil and carbon enriched soil.

As for the ditch, saturation level within the wetland is controlled by elevation of the drain outflow. Initially, three possible levels have been planned (Figure 16) in order to study level influence. However, due to leakages that resulted in unsaturated conditions of the wetland in 2011 and 2012 season, the outflow structure was modified in December 2012, allowing saturating conditions through operation at the highest level throughout monitoring season 2013. Water level with the modified design was measured using a piezometer (pressure-based water level sensor) in connection with a weir-shaped cut in the outflow pipe (Figure 16, right)

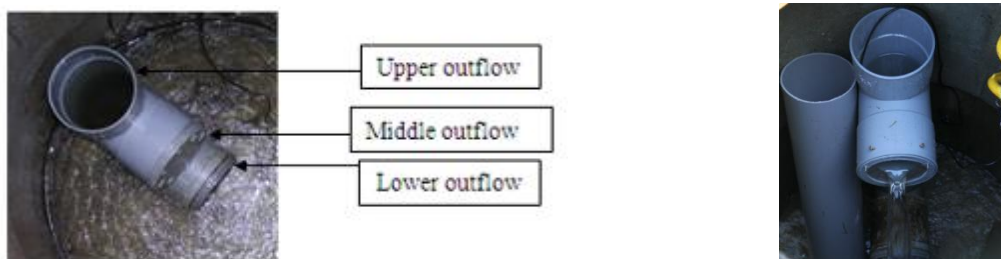

Figure 16: Top view of drain control structure in infiltration wetland. Left: initial structure allowing three outflow levels. Right: Modified structure for monitoring season 2013.

Surface wetland design

Cross section of the surface wetland is shown in Figure 17. More detailed design plans and adaptations to original design can be found in Appendix A and Appendix B. The wetland is permanently filled during flow conditions, saturated volume is estimated around 60 m³. Filling height is determined by height of the outflow weir, installed at the outflow pipe to determine flow leaving the surface wetland (Figure 18).

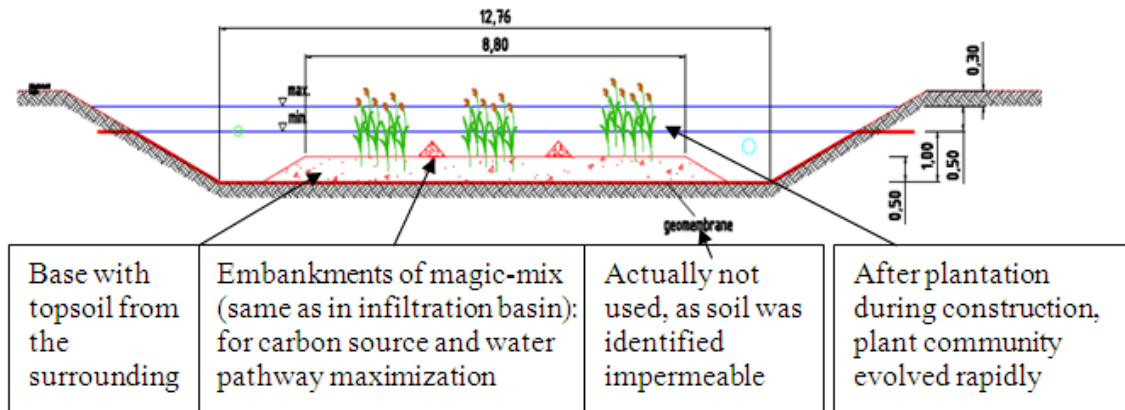

Figure 17: Longitudinal view of surface wetland (source: Akut Partner).

Inflow was measured by installation of a weir in the inflow shaft and subsequent measurement of water level by an ultrasonic level sensor (for details see Appendix C). Water level measurement in the wetland (to determine outflow) was realized by “Setude” using an ultrasonic measurement probe installed on a pole at the outflow pipe (for details see Appendix C). As aqueous plants growing at the measurement point can interfere with water level measurements, the area should be regularly cleared. However, as can be seen in Figure 18 (right picture), this was not realized all the time, affecting flow values (see also 3.3.2 about hydrologic results).



Figure 18: Measurement of outflow in surface wetland.

2.2.4 Flow measurement

In each system, inflow, outflow and overflow (where appropriate) were monitored to evaluate system hydrology. Other contributors to the water budget are presented in : rain Q_r , evapotranspiration Q_e , watertable input Q_w and leakages Q_l are not measured. Taking into account the small system sizes and low temperatures at which flow usually occurs, Q_r (direct rain input) and Q_e (evaporation/plant transpiration) can be assumed to be of minor importance for total water budget in comparison to inflow volumes.

Indications regarding water table inputs (Q_w) for the two wetlands were gained from measurements of water table heights using a piezometer situated between the wetland and the receiving river (see Figure 13). Leakages (Q_l) are difficult to measure; they were kept low by site isolation (e.g. impervious layer). Comparison of inflow and outflow gives further indications for leakages (see Chapter 3).

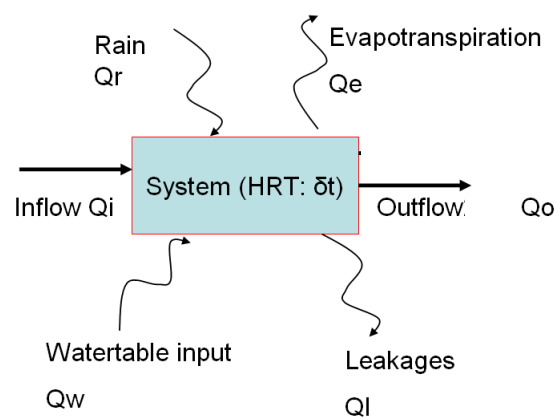

Figure 19: Water budget (HRT: Hydraulic Retention Time)

Additionally, the infiltration ditch was equipped with a piezometer in order to measure saturation level within the layers.

Water level is measured quasi continually (usually 5 min interval) with a water level or pressure sensor, and then converted into flow after installation of “V”-notch weirs. Only the inflow of the infiltration swale is equipped differently (Appendix 2), as a V-notch weir could not be installed in the inflow pipe. As the water level in the inflow pipe of the infiltration ditch was usually very low (few centimeters), the installed velocity sensor could not measure properly. Flows were then determined by water level measurements (from top) and calculated at the end of monitoring by calibrating water level heights with manually measured flows. However, resulting flow values showed a large variation (also due to flow conditions in the pipe) and have to be seen in connection with weekly manually measured flows (see Figure 23).

Where possible, automatically measured flows were validated by regular manual flow measurements using a 10 L bucket and stop watch (beside inflow surface wetland due to low position of inflow pipe).

All measurements and conversions require proper functioning of the installations (accuracy and sealing), calibrations and validations campaigns. More descriptions of monitoring devices are described in Appendix 2.

Due to restricted flow and problems regarding monitoring equipment (e.g. leaking weirs, animal damage of weirs; see also Appendix C) in monitoring seasons 2011 and 2012, flows

could only be determined during the 2013 season (December '12 – May '13).

2.2.5 Water quality monitoring

Water samples were regularly (every 1-2 weeks) taken as grab samples at inflows and outflows of the sites. In addition, occasional samples were taken from piezometer shaft within the swale.

General water quality parameters (temperature, oxygen content, pH, conductivity, redox conditions), were measured on-site using a YSI multiprobe meter. Samples were then sent the same day with ice packs to an accredited lab and analysed for different forms of N and P as well as DOC (for parameters see Table 5). Due to low flow conditions in monitoring seasons 2011 and 2012, most samples were taken in monitoring season 2013 (December '12 – May '13). However, in 2011 samples could be taken from beginning of January until end of February, including an intensive sampling autosampler campaign for evaluation of inflow variations. All sampling details are listed in Table 5. Precisions of measurements and analysis can be found in Appendix D.

Table 5: Components of water quality monitoring

	Grab sampling	Probe measuring	Autosampling
Frequency	Every 1-2 weeks	Every 1-2 weeks	Hourly, gathered in 24h-samples
Period	Whole flowing periods: 2011: 4.1. – 28.2. 2012: no flow 2013: 18.12.'12-30.5.'13	Same as grab sampling	Two 5 day campaigns in Jan/Feb 2011
Points	Inflows, outflows of all three systems	Like Grab sampling + additional points	Inflow of both sites (1x swale, 2x wetlands)
Parameters*	NO ₃ ⁻ , NO ₂ ⁻ , NH ₄ ⁺ , NTK _f , NTK, TP, PO ₄ ³⁻ , DOC	O ₂ (% and mg/L), Eh, Cond, T, pH	NO ₃ ⁻ , NH ₄ ⁺ , NTK, TP, PO ₄ ³⁻
Information	- Evolution of N and P species (esp. NO ₃) through the year - Potential transformation of some species within the system	- water physico-chemical parameters at inflow and changes within the system - Influences of these characteristics on processes	- Day-to-day variation of concentrations in inflowing waters

* DOC: Dissolved Organic Carbon

NO₃⁻: Nitrate

NO₂⁻: Nitrite

NH₄⁺: Ammonium

NTK_f: Total Kjeldhal Nitrogen, after filtration (only 2011 as values always < DL)

NTK: Total Kjeldhal Nitrogen, without filtration (only 2011 as values always < DL)

TP: Total Phosphorus

PO₄³⁻: Ortho-Phosphate

O₂: Dissolved Oxygen concentration

O₂%: Oxygen saturation

Eh: Redox Potential

Cond: Conductivity

T: Temperature

Chapter 3 Site Hydrology

3.1 Precipitation pattern

Precipitation data of Trémuson airport (~ 5 km east of sites) was analyzed by comparing monthly rain amounts of the three monitoring seasons (2010/11, 2011/12 and 2012/13) with 15-year-average from 1996-2010 (Figure 20). It can be seen that monitoring seasons 2010/11 and 2011/12 were much dryer with precipitation considerably below 15 year average during most months of monitoring (especially January, February and March), resulting in lack of flow. In 2012/13, monthly precipitation was close to 15 year average, resulting in a “normal” and average season regarding inflow at monitoring sites.

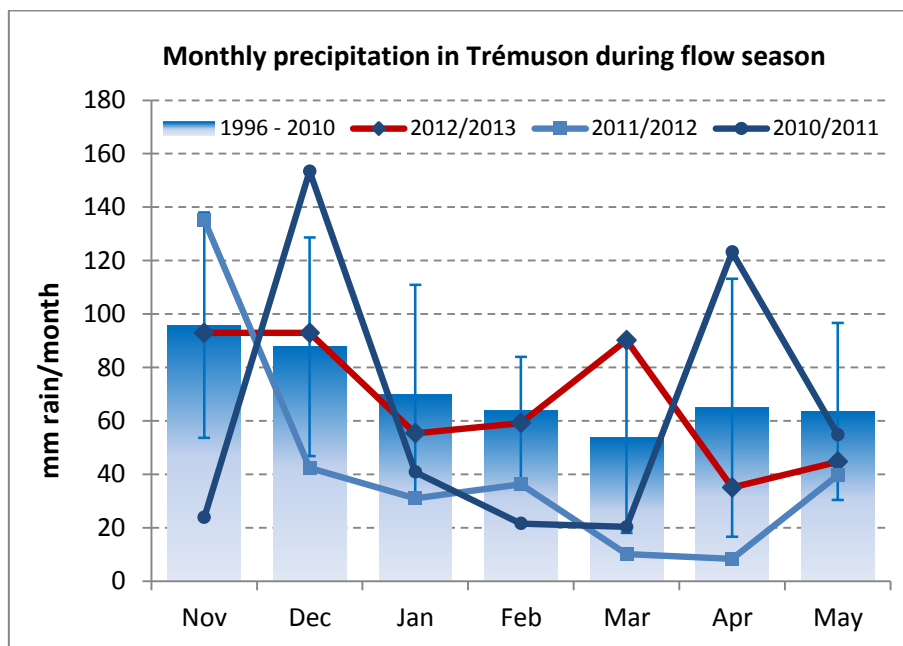

Figure 20: Precipitation at weather station in Trémuson, ~5 km from pilot sites.

3.2 Infiltration ditch

3.2.1 Hydraulic Retention Time (HRT)

Hydraulic retention time (HRT) was determined at average flow conditions (6-8 m³/h) in February 2013 and at low flow conditions (~ 1m³/h) in May 2013 with tracer tests (addition of salt at inflow with subsequent measurement of electric conductivity at outflow).

C-shaft

Hydraulic retention time in the C-shaft was determined to be 20 minutes at an inflow of 6.1 m³/h (see Figure 40 in Appendix G). With an estimated volume (from dimensions, considering straw cage) of 3 m³, theoretical residence time at 6.1 m³/h is 30 min (=1.5 times measured HRT), resulting in a hydraulic efficiency of 67%. This corresponds to a water volume of 2 m³ participating in exchange.

Infiltration ditch

Hydraulic retention time in the ditch was first determined under normal operation condition with drain valve partly open so water infiltrates to the drain at the bottom of the ditch and leaves ditch through the drain shaft. Under these conditions a sharp conductivity peak appeared with a maximum at HRT of just 25 minutes at an inflow of 7.9 m³/h (Figure 22 left). Considering the determined saturated volume of 8.7 m³ (with drain valve open, see 2.2.2.2) the hydraulic efficiency is 38%, suggesting that only a minor part of the water volumes in the ditch takes part in exchange due to preferential flow presumably through drainage layer. This corresponds to observations on site that water from the inflow pipe quickly infiltrates at the point of inflow (see Figure 21).



Figure 21: Inflow of ditch

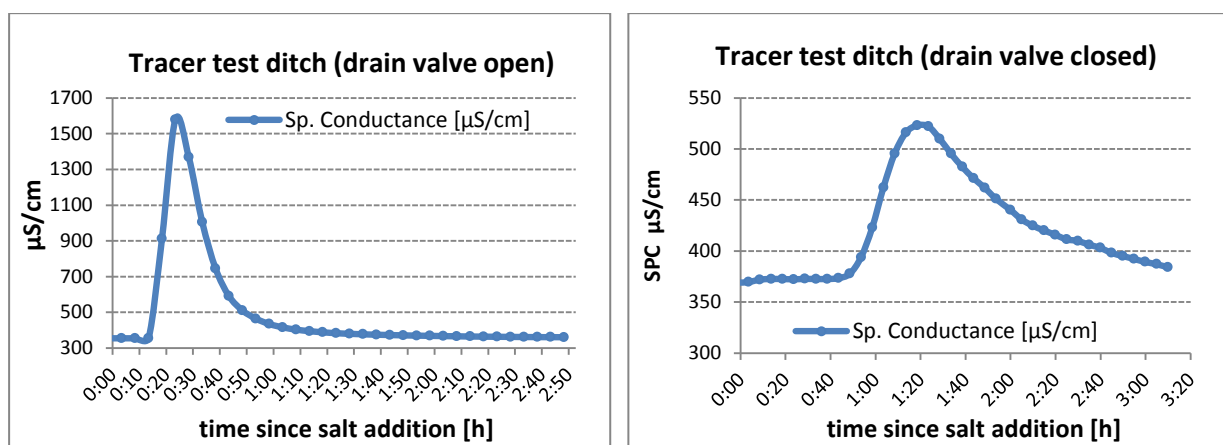

Figure 22: Results of tracer tests in infiltration ditch with drain valve open (left, inflow: 7.9 m³/h) and closed drain valve (water leaves ditch through overflow pipe) (right, inflow: 6.1 m³/h).

As a consequence, the drain valve was closed on 21.2.2013 and a second tracer test was conducted. When the drain valve is closed, water flowing through the drain is forced to vertically flow upwards to exit the ditch through the overflow pipe (Figure 11) instead of through drain, presumably extending hydraulic residence time. Results show that measured HRT is indeed increased to 1h 20 min (Figure 22, right), resulting in an increase of hydraulic efficiency to 67% (considering a saturated volume at overflow conditions of 12.9 m³ - see 2.2.2.2). Total residence time (ditch including C-shaft) was 1h 40 minutes (1.6 hours). The broader peak with more pronounced tailing also indicates that more water takes part in exchange. As a consequence, drain valve was kept closed until the end of the flow season. However, residence time was still low in comparison to planned average HRT of 2 d.

A further tracer test under low flow conditions was conducted in May 2013 at an inflow of 1.1 m³/h, resulting in an hydraulic residence time of 5.3 h (7.1 h including C-shaft). Both points were used to derive a relationship between inflow and HRT (regression to power function, see Table 12 in Appendix G). The average residence time (determined from weekly averages) was 0.044d or 1.1h (see Table 13 in Appendix I).

3.2.2 Flow measurements

Due to instrumentation and leakage problems of weirs, flow data is only available for the last monitoring season (December 2012 – June 2013).

Inflow to the infiltration ditch was measured by an ultrasonic level sensor installed in the inflow pipe, as measurements using a Doppler-type flow meter during first year of monitoring were unsuccessful due to the low water level. However, as water level in the inflow pipe was usually very low (<4 cm) and the water surface fluctuating from flow, measured values during monitoring season 2012/13 were still associated with a large error represented by large fluctuations of determined values (see Figure 23). Manual measurements conducted at each sampling to validate measured flows (usually once a week) show that especially at low inflows (<5 m³/h) actual inflows are lower than measured values (see April/May in Figure 23). For other times, manual measurements of inflows are generally in accordance with measured flows (middle of fluctuating inflow graph, see red triangles and light blue line in Figure 23).

Inflow values vary mainly between 5 and 15 m³/h during most time of the season (mid-December – mid-April) with higher peaks after intense rain events (especially on 11th and 12th March with a total of rainfall of 37 mm) reaching up to 55 m³/h. The average flow (determined from weekly averages) for the whole flow season 2013 (Dec '12- May '13) was 9.3 m³/h (see Table 13 in Appendix I). These values are much higher than inflows assumed for design purposes of ~ 1m³/h, resulting in shorter residence times.

Outflow was measured at monitoring point D1 (drain outflow) and E1 (overflow) in respective shafts. Until 21.2.2013 (closure of drain valve), outflow was the sum of flows at D1 and E1. However, due to leakage problems, flow of D1 could only be measured from 6.2. until 21.2., with large fluctuations, though (see dark blue line). Measurements of overflow (E1, equals total flow after 21.2.) worked without problems from 8.1. until end of monitoring. Results show that measured values are in accordance with manually measured values. Furthermore it can be seen that outflow equals inflow, indicating that no losses or additional inflows to the system are likely (Figure 23).

A piezometer installed within the ditch (C1.2) showed that the ditch was filled (saturated conditions) during whole flow season 2013 from mid-December 2012 until end of May 2013 (see Figure 45 in Appendix H).

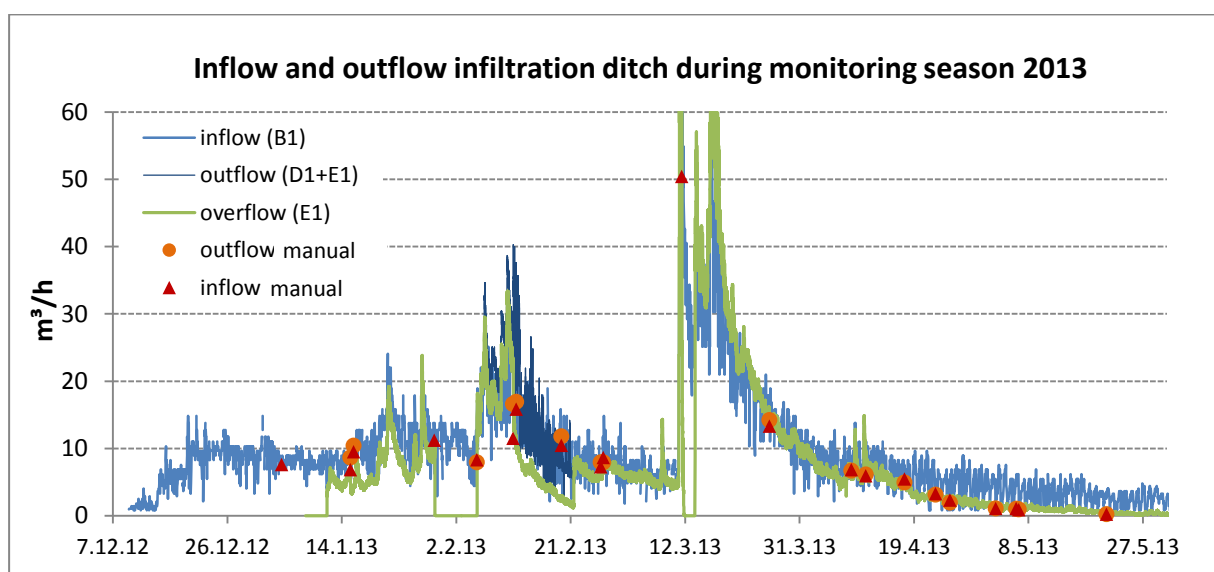

Figure 23: Inflow and outflow of infiltration ditch during monitoring season 2013. From 21.2. overflow (E1) equals total outflow due to closed drain valve. Before 21.2., outflow equals sum of D1 (data only from 6.2.13 due to instrumentation problems) and E1 (dark blue line).

3.3 Wetlands

3.3.1 Hydraulic retention time (HRT)

Hydraulic retention time at the wetland sites was determined at typical flow conditions ($\sim 3 \text{ m}^3/\text{h}$) in February 2013 and at low flow conditions ($< 0.4 \text{ m}^3/\text{h}$) in May 2013 at the end of flow season with salt-based tracer tests, similar to infiltration ditch. For the surface wetland, the second tracer test in May was unsuccessful due to battery issue of the conductivity meter.

Infiltration wetland

Two tracer tests with salt resulted in estimated HRT of 4.5 hours at an inflow of $3.1 \text{ m}^3/\text{h}$ (Figure 42 in Appendix G) and 33 hours at an inflow of $0.22 \text{ m}^3/\text{h}$ (Figure 43 in Appendix G). Both points were used to derive a relationship between inflow and HRT (see Table 12 in Appendix G). Considering the estimated saturated volume of 48 m^3 (see 2.2.3.2) the hydraulic efficiency is 30% at normal flow and 15% at low flow conditions, suggesting preferential flow (only minor part of the water volumes takes part in exchange). This indicates that the water is not infiltrating over the whole area of the wetland to the drainage layer, but instead shortcuts from the inflow area to the drainage layer resulting in a sharp increase of measured conductivity (see Figure 43 in Appendix G).

The average residence time (determined from weekly averages) was 0.17 d or 4 h (see Table 14 in Appendix I), which is much lower than average HRT of 11 d in design characteristics.

Surface wetland

Tracer tests conducted in February 2013 at an inflow of $2.9 \text{ m}^3/\text{h}$ resulted in an estimated HRT of 10 hours for the surface wetland (Figure 44 in Appendix G). Considering the estimated saturated volume of 60 m^3 (see 2.2.3.2) the hydraulic efficiency is $\sim 50\%$ at normal flow, showing that a larger part of the water volume takes part in exchange compared to infiltration basin. Slower increase and lower level of conductivity measured at the outlet also indicates a better mixing of inflowing water with the water body in the wetland. Higher hydraulic efficiency and larger volume of water in the system results in a longer residence time (\sim twice) in the surface wetland compared to the infiltration wetland.

The average residence time (determined from weekly averages) was 0.35 d or ~ 8 h (see Table 15 in Appendix I), which is twice as much as in the infiltration wetland, but still much lower than average HRT of 11 d in design characteristics.

3.3.2 Flow measurements

Due to instrumentation and leakage problems of weirs as well as damage (including cut cable and damage of weirs by animals, see also Appendix C), flow data for the wetlands is only available for the last monitoring season (December 2012 – June 2013).

Infiltration wetland

Saturated conditions were enabled during whole flow season 2013. Inflow and outflow of the infiltration wetland were measured by ultrasonic level sensors installed in the inflow and drain shafts. Results are presented in Figure 24, showing that outflow equals inflow measurements, indicating that no losses or additional inflows to the system are likely. Manual measurements conducted at each sampling to validate measured flows (usually once a week) show that measured values are generally in accordance with measured flows.

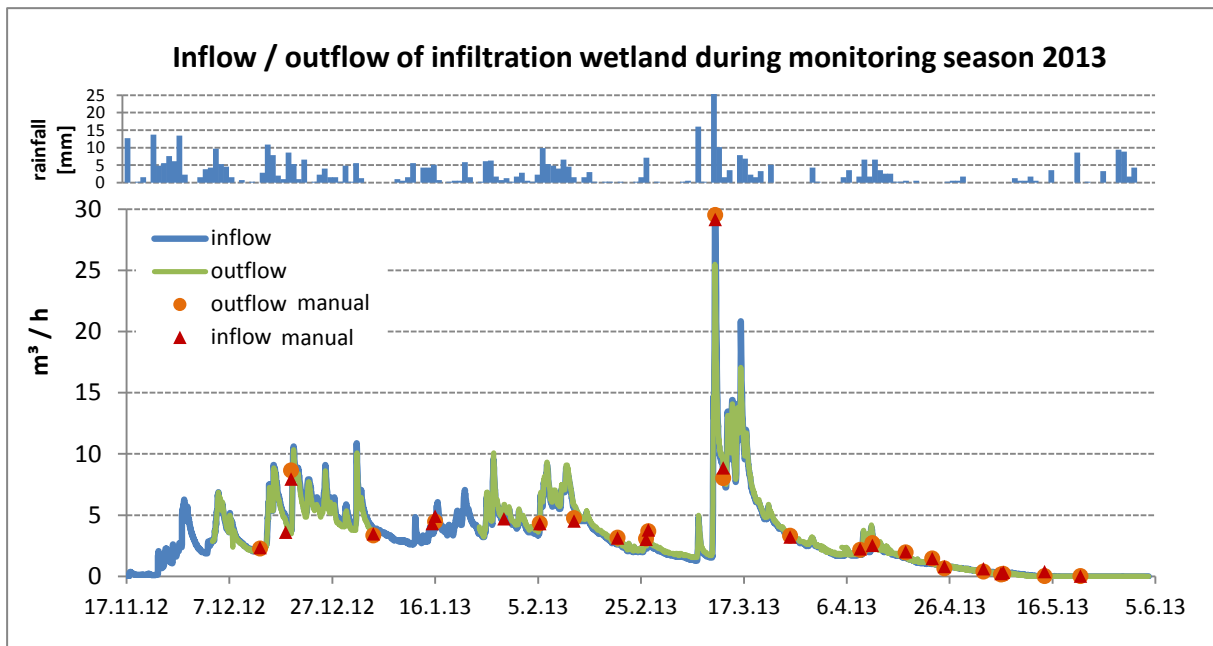

Figure 24: Inflow and outflow of infiltration wetland during monitoring season 2013. Daily rainfall from Tremuson climate station.

Inflow values vary mainly between 2 and 8 m³/h during most of the season (December – mid-April) with higher peaks after intense rain events (especially on 11th and 12th March with a total of rainfall of 37 mm) reaching up to 29 m³/h. The average flow (determined from weekly averages) for the whole flow season 2013 (Dec '12- May '13) was 4 m³/h (see Table 13 in Appendix I). These values are higher than inflows assumed for design.

Overflow (I6.1) was also measured by an ultrasonic water level meter (see Appendix C). However, no overflow occurred during the entire monitoring season

Surface wetland

After start of flow end of November 2012 the surface wetland was filled with water for the whole flow season. Results of flow measurements are shown in Figure 25. While inflow

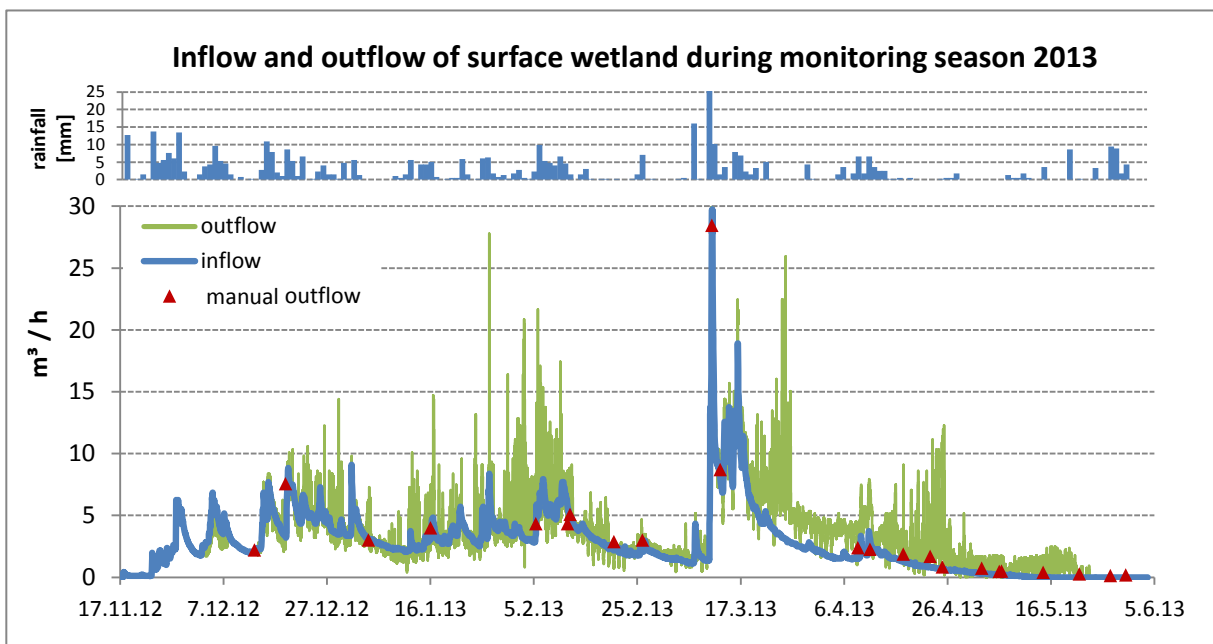

Figure 25: Inflow and outflow of surface wetland during monitoring season 2013. Inflow could not be determined manually due to low height of inflow pipe. Daily rainfall from Tremuson station.

measurements are very consistent and only slightly lower compared to inflow of infiltration wetland (see comparison in Figure 46, Appendix H), measured values of outflow are highly variable. This is likely due to interference of water plants growing at the measurement point influencing the ultrasonic beam (probe installation not optimal, see Figure 18). This is confirmed by the fact that fluctuation decreased a lot after clearing of plants mid-February. Comparison of manually measured outflow values (red triangles in Figure 25) with measured inflow curve (blue line) indicates that outflow is similar to inflow as in infiltration wetland.

With an inflow very similar to inflow of infiltration wetland (see Figure 46 in Appendix H), inflow values also vary mainly between 2 and 8 m³/h during most time of the season (December – mid-April). The average flow (determined from weekly averages) for the whole flow season 2013 was 3.5 m³/h (see Table 15 in Appendix I). These values are higher than inflows assumed for design.

3.4 Hydrology – Summary

While precipitation during the first two monitoring seasons (2011 and 2012) was much lower than the 15 year average with much shorter (2011) or no flow (2012), the third and last monitoring season was characterized by monthly precipitation values comparable to the long term average. This resulted in flow at both sites from end of November/beginning of December 2012 until end of May 2013. During this time, inflow and outflow of all three systems were very similar, indicating that inflow of groundwater or leakages are not likely. Inflow varied at both sites depending on rainfall with higher flow entering the infiltration ditch (average ~ 9 m³/h) compared to infiltration or surface wetland (average 4 and 3.5 m³/h).

Resulting residence times over time are summarized in Figure 26. It can be seen that HRT are low during most of monitoring season (until April) with values <0.5 d in all systems and <2 h in infiltration ditch. When flow decreases below 1 m³/h in infiltration ditch and below 2 m³/h in wetlands (after mid-April), HRT increases >0.5 d (Figure 26).

Despite normal rainfall pattern, residence time is too low for sufficient nitrate retention, and also much lower than in planning documents (average HRT of 2 d in swale and 11 d in wetland), potentially due to higher than expected flows. Therefore, information on flow at anticipated sites is important in order to achieve sufficient residence times.

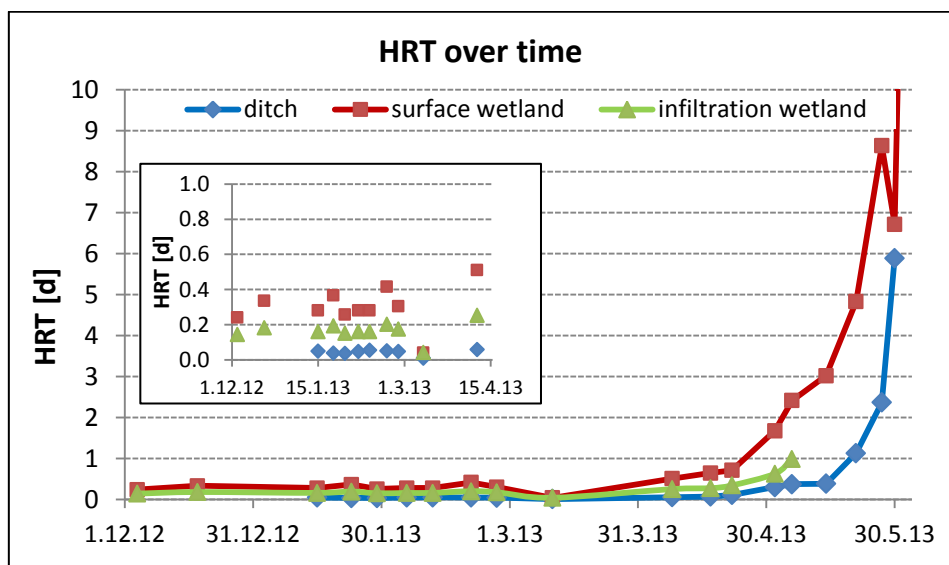

Figure 26: Hydraulic residence times (HRT) for infiltration ditch and wetlands (from manual flow measurements; for equations defining relationship between flow and HRT see Table 6 in Appendix H).

Chapter 4 Water quality results

4.1 Inflow Quality

The water quality of the inflowing water is very similar at both sites (Table 6) and characterized by:

- High and stable concentration of nitrate around 55 mg/L (12.4 mg-N/L). Other nitrogen forms (e.g. ammonium, nitrite) are measured at low concentrations <0.3 mg/L. Total Kjeldahl nitrogen (TKN) was below limit of detection (1 mg/L) in 2011 samples and therefore not measured anymore during 2013 monitoring season.
- Low concentration of dissolved organic carbon DOC (between 1.5 mg/L and 4.0 mg/L)
- Low phosphate concentrations fluctuating mostly between 0.10 mg/L and 0.25 mg/L.

Averages of water quality parameters for both sites are listed in Table 6. An overview of all measured values can be found in Appendix K.

Table 6: Averages and standard deviations of water quality parameters from inflow for both sites for all measured inflows in 2011 and 2013 flow season.

	NO ₃ [mg/L]	NH ₄ [mg/L]	NO ₂ [mg/L]	DOC [mg/L]	PO ₄ [mg/L]	Conductance [μS/cm]	O ₂ [%]	Temperature [°C]	pH
Inflow Ditch S(x)	54.2 ± 4.7	0.06 ± 0.06	0.11 ± 0.09	2.4 ± 0.7	0.16 ± 0.07	364 ± 29	81 ± 14	9.3 ± 1.7	7.3 ± 0.3
Inflow Wetlands S(x)	56.9 ± 13.1	0.01 ± 0.01	0.01 ± 0.01	2.7 ± 0.4	0.07 ± 0.03	399 ± 31	90 ± 12	8.5 ± 1.4	7.3 ± 0.3

Nitrate

Nitrate concentrations in inflow to both sites (Figure 27) show a decreasing trend during monitoring season which is a bit more pronounced for the wetland site (high concentrations of 85 mg-NO₃/L in December decreasing to 40 mg-NO₃/L in May) compared to inflow to the ditch (62 mg-NO₃/L in January decreasing to 45 mg-NO₃/L in May). This could be due to wash-out effects in the drainage-effected soil of the catchments during the course of the flow season. The low point in mid-March corresponds to an extreme rain event (see also Chapter 3) that resulted in an unusually high dilution of drainage water with rain.

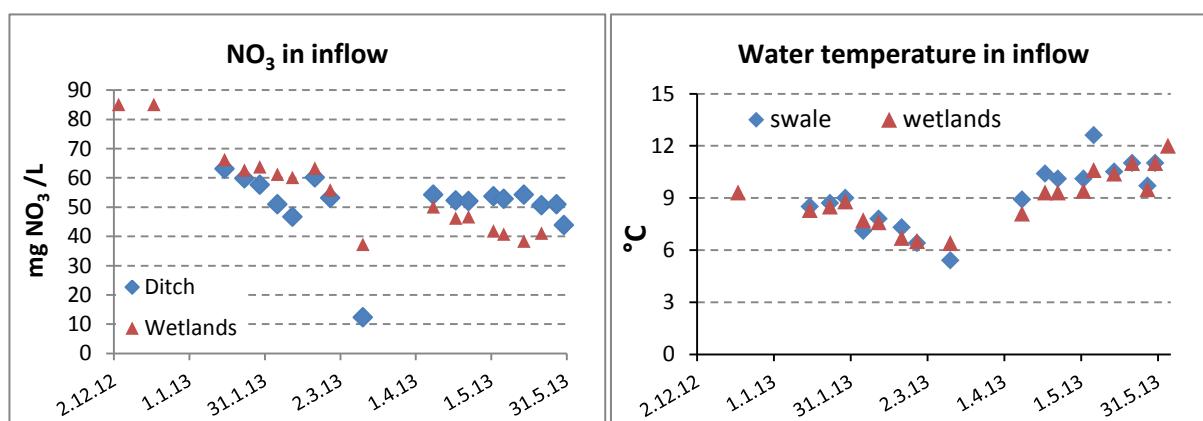

Figure 27: Nitrate concentrations and water temperature in inflow to both sites during monitoring season 2013.

Water temperature

Water temperature in inflowing water during flow season 2013 varies between 6 and 12°C at both sites (Figure 27). While temperatures are below 9°C during most time of monitoring, they increase in spring time after mid-April. As low temperatures negatively affect microbial processes, temperature range observed at both sites is likely to limit denitrification performance.

4.1.1 Everyday fluctuations

To evaluate everyday fluctuations in the inflow of the systems (for design of monitoring, e.g. sampling frequency) an autosampler campaign was conducted at both sites in January and February 2011. Samples were taken every hour to generate 24h-composite samples that were analysed for nitrate. Equal concentrations with very low fluctuations were observed at both sites with concentrations between 56 and 57.5 mg-NO₃/L (see Figure 48 in Appendix I).

4.2 Nitrate retention

Comparison of relative nitrate retention ($(c_{in}-c_{out})/c_{in} \cdot 100\%$) for flow season 2013 is shown for all three systems in Figure 28 in comparison with inflow values for the wetland systems. It can be seen that retention is low (<10%) for most time of the season until inflow drops in April with subsequent increase of hydraulic retention time (see Figure 26 for HRT). At the end of the season (end of May) at very low inflows nitrate retention increases above 50%, demonstrating that systems are generally capable of reducing nitrate concentrations if designed properly or run under more favorable conditions (e.g. lower inflow, higher T). However, reduced absolute nitrate loads at very low inflows are small in comparison to inflow loads during average inflow (see 4.2.2).

These values are comparable to results from flow season 2011, during which nitrate retentions <10% were determined during most time until end of flow season, when retention increased up to 30% in infiltration wetland (see Figure 49 in Appendix I). However, no flow could be determined in 2011 due to instrumentation problems.

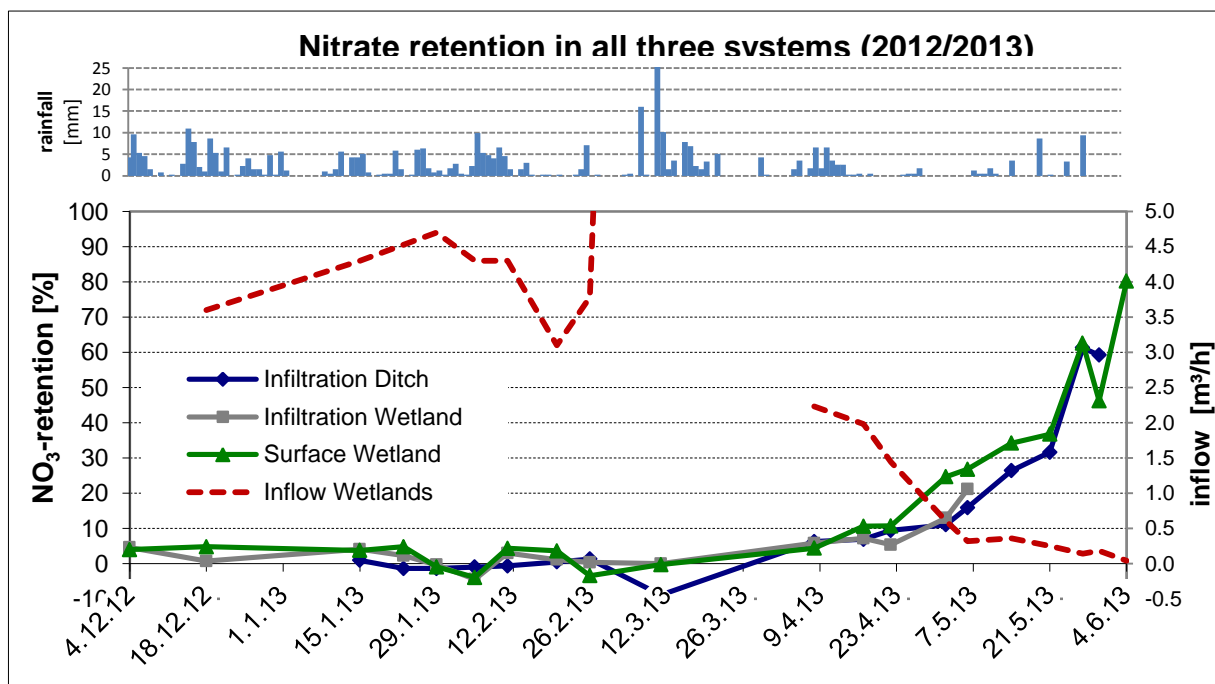

Figure 28: Relative nitrate retention in all three systems during monitoring season 2013 and inflow to wetlands. Upper graph shows daily rainfall at climate station in Tremuson (~ 5km from sites).

Other nitrogen species (ammonium and nitrite) remain low (<0.3 mg/L) in all three systems during the whole season (see 4.3).

The relationship between inflow and relative nitrate retention is shown in Figure 29 demonstrating that nitrate retention >20% can only be achieved in the current systems when inflow is below 0.5 m³/h.

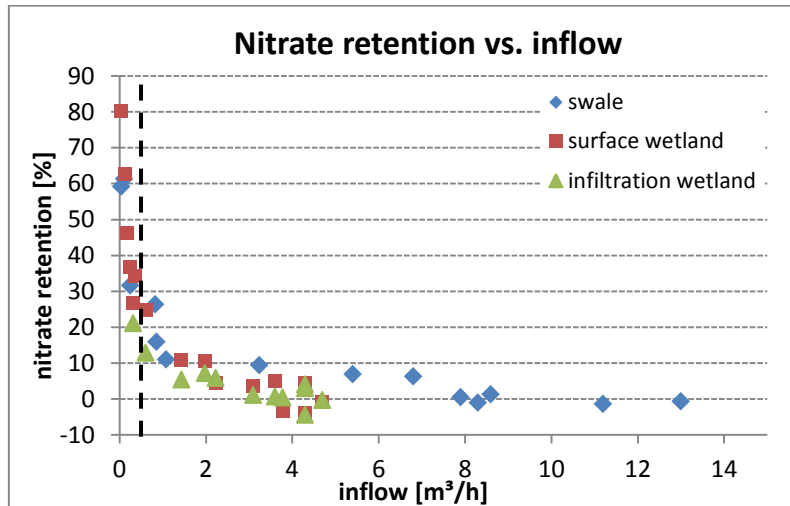

Figure 29: Relationship between nitrate retention and inflow to the systems (dotted line: 0.5 m³/h).

Nitrate retention vs. HRT

In Figure 30 nitrate retention is displayed as a function of HRT showing a linear relationship for all three systems. While in both wetlands retention increases continuously with increasing HRT, in the infiltration ditch no further nitrate reduction can be observed after 2 days HRT indicating limitations (e.g. carbon availability). However, only one data point at HRT of ~6 d is available (Figure 30 left). Functions were used to determine nitrate retentions for the continuous flow data measured at the sites during flow season 2013 within the range of shown relationships (interpolation, no extrapolation). Steeper slopes for the ditch and infiltration wetland indicate higher efficiency for subsurface systems (higher retention at low residence times) compared to surface wetland.

It has to be kept in mind, though, that higher retention times at the end of monitoring season (caused by decreasing inflows) coincide with increasing temperatures due to seasonal changes (from winter to spring). However, relationship between temperature and nitrate retention is less distinct (see below), indicating that HRT is the dominating factor at the prevailing temperature range.

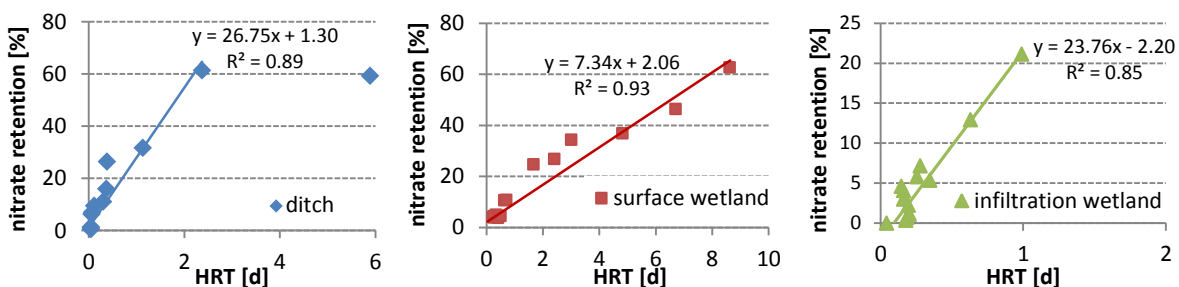

Figure 30: Relationship between nitrate retention and hydraulic retention time HRT (regression for ditch (left) does not consider last point at HRT of 5.9).

Nitrate retention vs. temperature

Figure 30 also shows that for the investigated systems an HRT > 0.5 d for the infiltration ditch and > 1 d for the wetlands is necessary to reach a nitrate retention > 20%.

During spring time water temperature increases from about 6°C end of February to about 11°C end of May (see also Figure 27).

However, as mentioned above, increasing temperatures coincide with increasing HRT due to decreasing flow in spring time towards the end of the flow season. In Figure 31, nitrate retention is plotted against water temperature to elucidate if temperature or HRT exhibits a stronger relationship (see also regression matrix plot in Appendix I, Figure 50). It can be seen that the general trend is an increase of nitrate retention with increasing temperature, however, the correlation is much weaker compared to

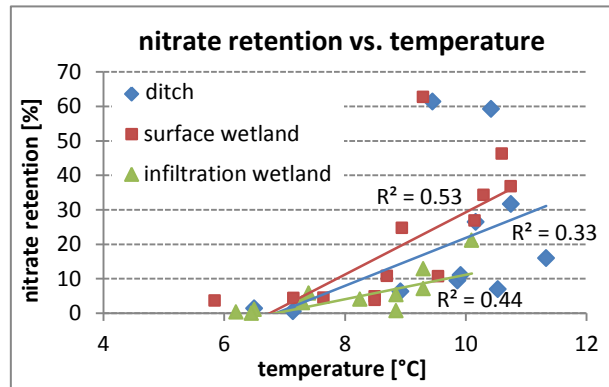

Figure 31: Nitrate retention versus temperature during flow season 2013.

to HRT (e.g. very different retentions of 10% and 60% for same temperature of 9.5°C in surface wetland and infiltration ditch in Figure 31), suggesting that HRT is more relevant than temperature within the observed ranges. Linear multiparameter regression analysis (retention = $a \cdot \text{HRT} + b \cdot \text{Temp}$) showed an about three times higher factor for HRT ($a=6.5$, $b=2.3$), also confirming that HRT is more relevant. However, as temperature is a driving parameter for microbial activity, further increase of temperature above 11°C (e.g. to 20°C) is likely to positively affect nitrate retention (see also temperature dependence in technical scale results at UBA in Figure 32).

Effect of carbon addition through C-shaft in infiltration ditch

To increase available organic carbon as an energy source for denitrifying heterotrophic bacteria in the infiltration ditch, a concrete shaft was installed just upstream of the ditch that included a cage filled with straw as easily degradable and replaceable carbon source (C-shaft, see 2.2.2.2). As can be seen in Table 7, DOC concentrations do not increase, even at low inflows and subsequent higher contact time of inflowing water with the straw in the shaft demonstrating that this approach was not successful in reality. However, at very low inflows of 0.1 m³/h with resulting contact times of about 1 day denitrification within the C-shaft can be observed (15%). It can be concluded that easily degradable organic carbon released by decomposition of the straw as organic substrate will not be released but used up completely at the same place by denitrifying bacteria, at least at prevailing temperatures around 10°C. Contact time of inflowing water with the straw during average flow conditions of 8 m³/h is too low at prevailing temperatures to achieve considerable degradation of straw.

Table 7: Selected data for inflow, DOC-increase and nitrate retention in C-shaft of infiltration ditch.

Inflow [m ³ /h]	DOC increase [mg/L]	nitrate retention [%]
7.9	0.1	0%
3.1	-0.1	1%
0.8	-0.4	2%
0.1	0	15%

4.2.1 Swale: comparison with UBA data (technical scale swale)

Investigations at German Environmental Agency (UBA) as part of the Aquisafe project included denitrification experiments in two 8 m long technical scale swales filled with a bark mulch/straw mixture that were operated for >1 year at retention times of 0.4 days and 2.5 days, respectively. While retention times in the infiltration swale in Brittany were lower for most of the season, two points at the end of flow season with an HRT of 0.4 and 2.3 days could be compared with nitrate retentions in the technical swales. Figure 32 shows nitrate retention relative to temperature for both technical swales (for swale operated at 2.5 days only aged conditions comparable to situation in Brittany swale are shown as a big difference was observed for fresh substrate – see report D5.3). The two values obtained from the infiltration ditch in Brittany are comparable with technical swale results at prevailing temperatures around 10°C despite different designs and substrates. However, as for most of flow season HRT in Brittany ditch was much lower than 0.4 days, no nitrate retention at other temperatures are available for comparison.

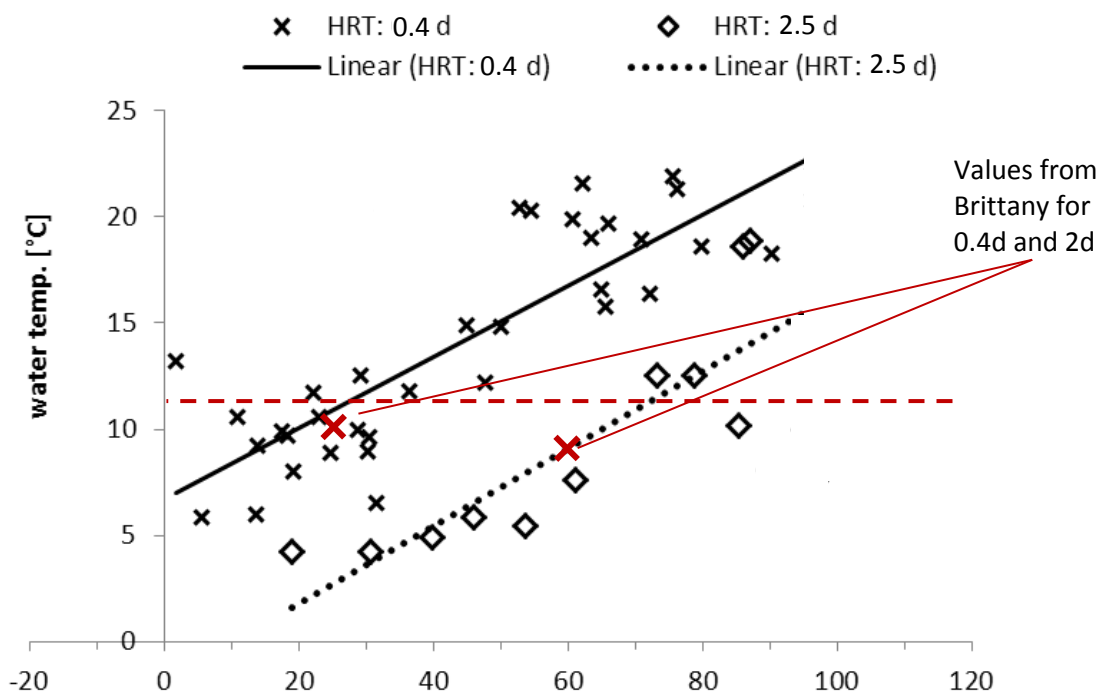

Figure 32: Comparison of selected results for nitrate retention in infiltration ditch in Brittany with results of two technical scale swales run at HRT of 0.4d and 2.5d (aged substrate) at UBA as part of the Aquisafe project.

4.2.2 Reduced Loads

Daily load reductions of nitrate were calculated from flow data and relative nitrate retention in all three systems (Figure 33). Reduced nitrate loads are mostly below 0.5 kg NO₃/d (=1.7 g NO₃-N/m³/d, with V_{swale}=66 m³), which is low compared to results of technical swales at UBA, which resulted in retained nitrate loads at 9°C and HRT of 0.4 d of 8 g NO₃-N/m³/d. The higher efficiency of technical swales is likely due to the fact that these are entirely filled with reactive material (bark mulch/straw mixture) allowing a more efficient use of reactor volume for denitrification, whereas the infiltration ditch in Brittany is mostly filled with sand and gravel with only 10 cm layer of organic substrate (wood chips).

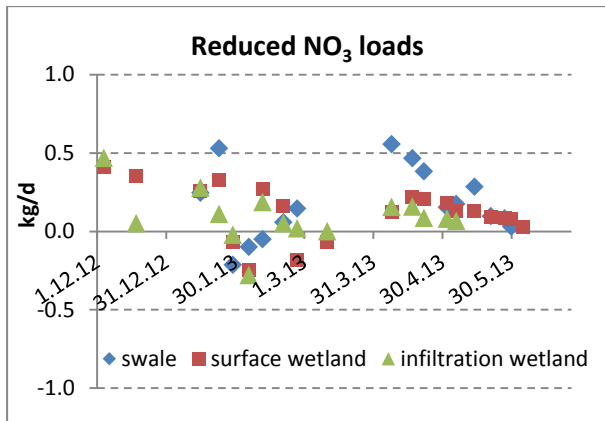

Figure 33: Reduced nitrate loads for all three systems during flow season 2013.

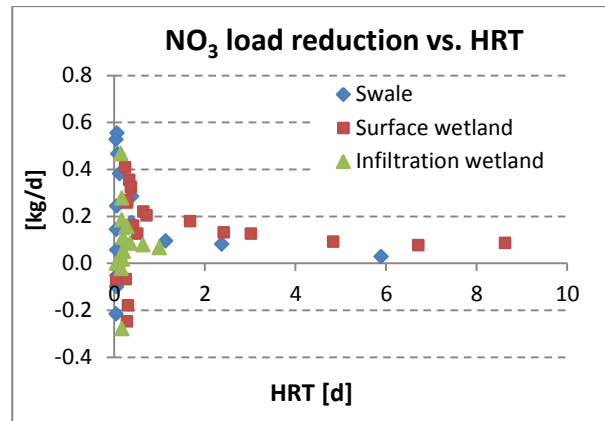

Figure 34: Nitrate load reductions vs. HRT.

Despite higher relative nitrate retention at higher HRT (see Figure 28), higher HRT from decreasing inflow to the system does not result in higher daily NO₃-load reduction, as inflowing nitrate mass also decreases with decrease of inflowing water volumes (Figure 34).

Nitrate loads for monitoring season

Inflowing and reduced nitrate loads for the whole flow season were summed from weekly averages (Table 13 – Table 15 in Appendix J). Results are summarized in Table 8 showing that approximately between 723 kg (surface wetland) and 1564 kg (ditch) of nitrate entered the systems. In the same time, only 13-24 kg NO₃ were reduced, resulting in low average retentions over the whole season between 1.5% and 3.0% in all three systems. Low average HRTs between 0.04 and 0.37 days and low temperatures between 6 and 11°C are likely reasons.

Comparing the two wetlands, a higher (twice) retention can be observed for the surface wetland, likely due to the higher average HRT (also twice). As the average inflow to the infiltration ditch is ~3 times higher compared to average inflow to the wetlands (at similar sizes), direct comparison is difficult. Therefore, hypothetical lower (1/3) weekly inflows to the ditch and resulting nitrate retentions were calculated (grey row in Table 8). At similar inflows, the infiltration ditch is a bit more efficient reducing 4% of the inflowing 549 kg NO₃.

Table 8: Summed nitrate loads for whole flow season 2013, calculated from weekly averages. Grey row shows values for hypothetically lower inflow to the ditch similar to wetland inflow.

	area [m ²]	Ø inflow [m ³ /h]	Ø HRT [h]	Σ NO3 in inflow [kg]	Σ NO3 reduced [kg]	NO3 reduced [%]
Ditch	185	9.3	1.1	1564	24	1.5%
Ditch (reduced inflow)	185	3.1	2.8	539	21	4.0%
Infiltration wetland	200	3.7	4.3	837	13	1.6%
Surface wetland	200	3.2	9.0	723	22	3.0%

4.3 Additional water parameters

DOC

Carbon concentration in inflows and outflows of all three systems remain low at concentrations between 1.4 and 4 mg/L (see Figure 36), so supply of carbon through organic substrate is necessary. Only exception is one sampling during an unusually intense rain event mid-March, at which inflow DOC-concentrations of 7 mg/L in the ditch and 5 mg/L in the wetlands were measured, probably due to surface runoff. No considerably increase of DOC concentrations within the systems can be observed, aside from a small increase by ~ 1-2 mg/L at the end of flow season in May at high HRT (Figure 36).

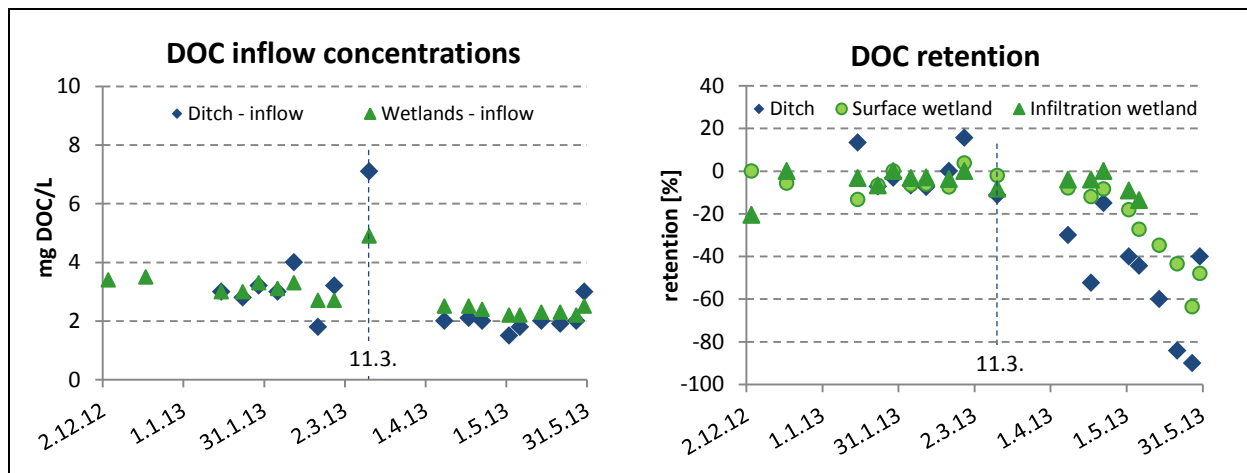

Figure 35: DOC inflow concentrations and retention in wetlands and infiltration ditch during flow season 2013 (note: sampling on 11.3. was done during extreme rain event with very high flows).

Ammonium and Nitrite

Ammonium concentrations are low (usually between below detection limit DL of 0.02 mg/L to 0.05 mg/L with occasional concentrations >DL up to 0.5 mg NH₄/L in inflow and outflow), indicating no influence of wastewater in the catchment (Figure 36). The only observable trend is a slight increase of outflow concentrations (to 0.2 mg/L) in the infiltration ditch at the very end of flow season during high contact times, potentially because of degradation of plant material (e.g. algae) in the shallow water close to outflow pipe at very low discharge flows.

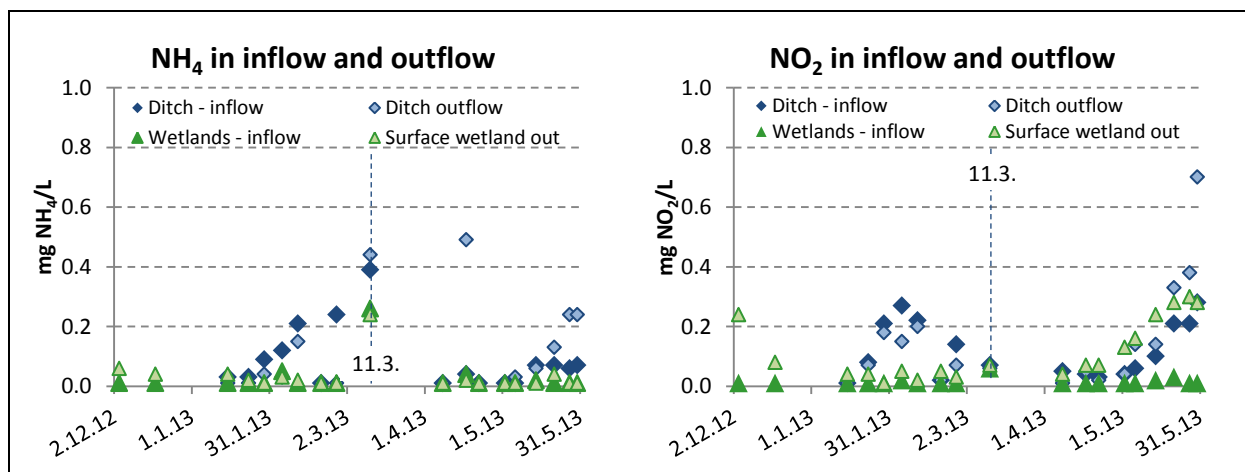

Figure 36: DOC, NH₄, NO₂ and PO₄ in inflow and outflow of wetlands and infiltration ditch during flow season 2013 (note: sampling on 11.3. was done during extreme rain event with very high flows).

Nitrite concentrations are also mostly below or close to detection limit of 0.02 mg/L until end of April (Figure 36). When inflow decreases <math><1\text{ m}^3/\text{h}</math> in May, a small increase to 0.3 mg NO_2/L in the surface wetland (May: <math><\text{LOD}</math> in inflow; \varnothing 0.13 mg/L in outflow) and 0.7 mg NO_2/L in the infiltration ditch (May: \varnothing inflow: 0.15 mg/L, \varnothing outflow: 0.29 mg/L) can be observed (indication of incomplete denitrification). In the infiltration ditch, inflow concentrations are occasionally elevated up to 0.25 mg NO_2/L (February and May). No elevated inflow concentrations can be observed for the wetland inflow.

Total P and PO_4

Total P concentrations are below detection limit (0.1 mg P/L) in inflow and outflow of the two wetlands and at an average of 0.1 mg/L in the ditch for most time of flow season beside an inflow spike from overland flow at 0.5 (wetlands) – 0.77 (ditch) mg/L during the extreme rain event in mid-March (Figure 51 in Appendix I). During this rain event, outflow concentrations of total P were decreased by ~25% in surface wetland and the ditch and by 50% in the infiltration wetland. In the infiltration ditch total P concentrations are higher at subsurface sampling point C1.2 located in the ditch (\varnothing 0.24 mg/L).

Phosphate (PO_4)-concentrations are shown in Figure 37, varying between <math><\text{LOD}</math> (0.025 mg PO_4/L) and 0.25 mg PO_4/L except for a concentration spike during the extreme rain event in mid-March of up to 0.6 mg/L. Whereas some increase of phosphate to 0.14 mg/L can be observed for the infiltration wetland (especially December-February, maybe leaching from amended soil substrate), reduction to <math><\text{LOD}</math> in warmer months (from mid-April) can be seen for the surface wetland, potentially due to uptake by algae in the water column. In the ditch, average inflow of 0.17 mg/L is reduced on average by 28% to 0.12 mg/L, especially at the end of flow season in May, when outflow concentrations remain at 0.1 mg/L while inflow concentrations increase to 0.25 mg/L. As water exits the ditch through the overflow since 20.2.2013 with resulting water column of about 5-10 cm above substrate, PO_4 -uptake by observed algae is a possible mechanism.

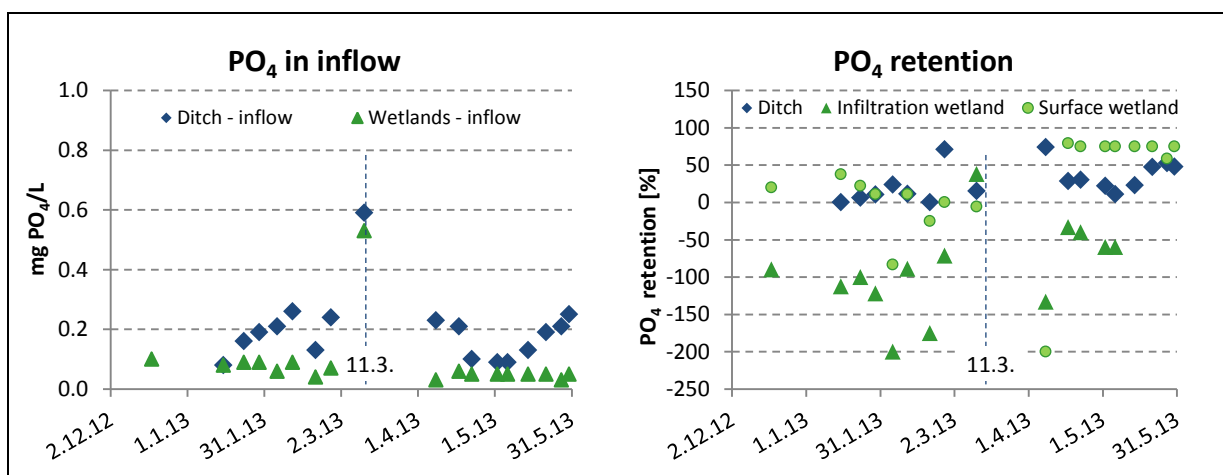

Figure 37: Phosphate inflow concentrations and retention in wetlands and infiltration ditch during flow season 2013 (note: sampling on 11.3. was done during extreme rain event with very high flows).

Other parameters

Specific conductance ranges mostly between 350 and 450 $\mu\text{S}/\text{cm}$, with lower values (170-270 $\mu\text{S}/\text{cm}$) during the extreme rain event in mid-March due to high proportion of rainwater (Figure 52 in Appendix I). These are typical values for surface waters.

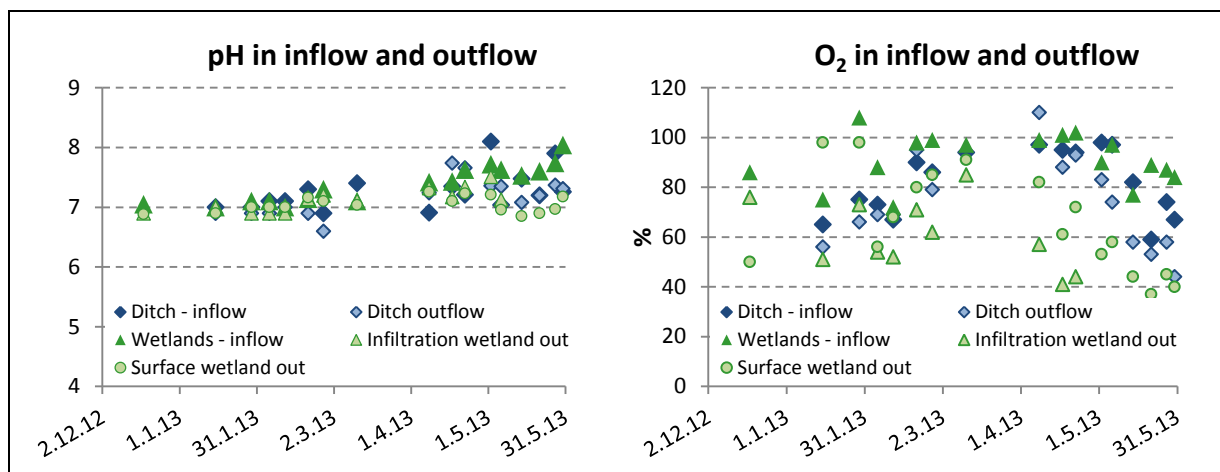

Figure 38: pH and oxygen concentrations in inflow and outflow of all systems.

Values of pH in inflow and outflow of all three systems are shown in Figure 38 and range between 6.8 and 7.2 until March. From April until end of flow season in May pH values in inflow slightly increase in both sites (ditch and wetlands). However, outflow concentrations remain around 7 (Figure 38). As denitrifiers operate best in the range $6.5 < \text{pH} < 7.5$ (Kadlec and Wallace, 2009), pH conditions occurring at both sides are good for efficient denitrification.

Oxygen measurements exhibit a large range from 40%-110%. It has to be kept in mind, though, that measurement of oxygen can be easily affected by diffusion of oxygen from the atmosphere into the sample during measurement, resulting in higher variability of measured values. In addition, oxygen concentrations within the systems are likely to be lower (e.g. in subsurface layer of infiltration wetland). Nevertheless, some trends can be observed. O₂ in inflow to the wetlands is high (usually >80%), whereas inflow to the ditch is more affected by upstream processes in the inflowing water (e.g. O₂ consumption through degradation processes of leaves and other organic material in the tree-shaded part just before the inlet), especially at low flows and higher temperatures in May. Although not favorable for the upstream water body, lower oxygen inflow is favorable for the systems as denitrification requires anoxic conditions. Furthermore, oxygen concentrations decrease in outflow of all three systems at decreasing

Table 9: Summary of ranges of parameters relevant for denitrification in investigated systems

Parameter	Conditions in pilot systems	Evaluation for denitrification
Temperature	5-12°C	better at higher temp, but cannot be influenced
Redox	100-250 mV	Anoxic, ok for denitrification
pH	7.3 ± 0.3	ok for denitrification
DOC	2-4 mg/L in inflows and outflows	Low, supply of carbon through organic substrate in system
Nitrate	~ 55 mg-NO ₃ /L average in inflows	High, no limitations by nitrate expected
HRT	∅ 0.05 d (ditch) – 0.35 d (surface wetland)	Too low for efficient denitrification, should be > 1 d

flows and higher temperatures at the end of flow season (degradation processes). However, outflowing water is re-oxygenated at the outlet through free-falling discharge.

Values for redox potential range mostly between 100 mV and 250 mV (see Figure 53 in Appendix I) indicating anoxic conditions in the systems, which are favorable for denitrification (Kadlec and Wallace, 2009).

In 9, parameters relevant for denitrification and respective value ranges measured in investigated pilot systems are summarized. In all three systems HRT, temperature and DOC are not optimal for efficient denitrification. Whereas prevailing temperature cannot be influenced, hydraulic retention time and available carbon can be influenced by system design.

Chapter 5 Conclusions and Recommendations

All three implemented near-natural mitigation systems (infiltration ditch and two wetland types) exhibited only low average nitrate retention over the whole flow season (1.5-3%) which is less than expected from planning. Most likely reason is that flow rates are much higher than expected and resulting hydraulic retention times very low (e.g. only 1 hour on average in infiltration ditch instead of planned average of 12h). However, increase of relative nitrate retention to up to 80% during low flow conditions at the end of flow season in May with higher HRT and increasing temperatures show that these systems generally work when designed properly. Similar relative retentions compared to the technical scale swales (UBA) at comparable temperature and HRT ranges also indicate general functionality of the systems.

Carbon can also still be a limiting factor as DOC concentrations in inflow remain low (1.5-4 mg/L) and do not increase after carbon shaft of infiltration ditch. Temperatures and hydraulic retention times might be too low for sufficient degradation of available carbon sources. Presence of more easily degradable carbon within the systems could improve nitrate retention, especially fresh substrate of easily degradable substrates (e.g. straw). Experiments at technical scale swales at UBA have shown that complete nitrate retention is possible even at low temperatures with fresh, non-aged substrate (mixture of straw and bark mulch added in after summer) and at a hydraulic retention time of 2 days (see report D5.3).

The following two sections give recommendations for the existing systems and newly built systems for mitigation of nitrate in agricultural catchments.

5.1 Recommendations for existing systems

To establish denitrifying conditions, infiltration systems (ditch and wetland) should be kept saturated at all times. For the infiltration ditch, drain valve should be kept closed with subsequent outflow through the overflow pipe as this will result in ongoing increase of hydraulic efficiency. To increase hydraulic efficiency in the system, treatment of partial flow has been considered. However, as can be seen in Table 10, partial treatment of incoming water does not improve total retained nitrate loads as untreated nitrate loads increase with decreasing treated fraction. Therefore, this option is not recommended.

To increase easily available carbon in existing systems, vegetation in the wetlands should be cut shortly before flow season (e.g. in October/November) and left in the wetlands for

Table 10: Partial treatment of inflow to the ditch assuming inflow of 4 m³/h and calculated resulting performance towards total nitrate load retention.

flow treated	Fraction	HRT	nitrate retention	load reduced	load treated	load un-treated	total load of outflow	load retention
[m ³ /h]	[%]	[h]	[%]	[g/d]	[g/d]	[g/d]	[g/d]	[%]
4	100%	2.2	3%	124	4676	0	4676	2.6%
2	50%	4.2	5%	115	2285	2400	4685	2.4%
1	25%	7.8	9%	108	1092	3600	4692	2.2%
0.5	13%	14.6	17%	100	500	4200	4700	2.1%

degradation during flow conditions. For the ditch, straw in the C-shaft should be exchanged every year shortly before or at the beginning of flow. Preferential flow in the shaft around the straw cage should be avoided by filling the space between shaft wall and cage (e.g. with bags of straw). Although this is unlikely to sustainably increase DOC in outflow of shaft, denitrification within the C-shaft could be increased.

5.2 Recommendations for new systems

To reach a nitrate retention >30% for new built systems of same design at similar climatic and flow conditions (flow only during winter and spring months at mild winters, e.g. at other places in Brittany), average hydraulic retention times >1 day for the infiltration swale, >1.5 days for infiltration wetland and >3 days for the surface wetland should be established (see Figure 40). Under flow conditions present at investigated sites this would lead to retained nitrate loads of >470 kg NO₃/year for the infiltration ditch and >240 kg NO₃/year for each wetland.

Improvements of system design could further increase nitrate retention. To ensure sufficient carbon availability at low inflow DOC a higher content of organic substrate could be established. For the ditch investigations of technical scale swales at UBA resulted in recommendation of bark mulch and straw mixture as substrate (see report D5.3). These investigations showed that the ditch could be totally filled with this substrate mixture ensuring high hydraulic conductivity for long time (>1.5 years) due to the structural stability of the bark mulch. Installation of a separate C-shaft would not be necessary.

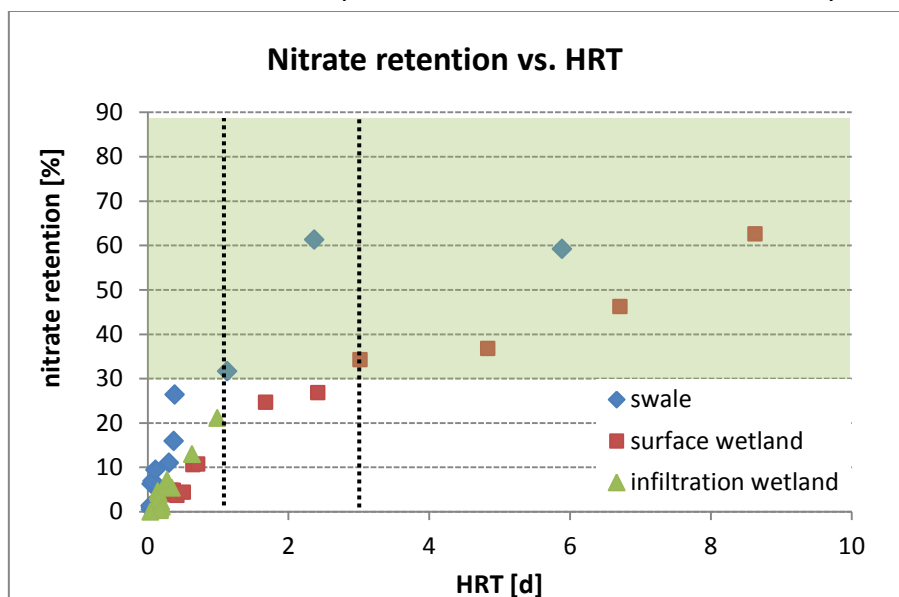

Figure 39: Necessary HRT in investigated mitigation systems to reach >30% nitrate retention.

An important point for new built systems is good knowledge of inflow conditions (flow periods, average inflow, peak flows). New systems have to be sized for realistic inflow rates to provide sufficient retention times.

Regarding choice of systems, available areas and situation at potential implementation sites have to be considered. Usage of existing ditches could be an easy option for implementation of reactive swales/ditches that contain substrate as carbon source, surface area for biofilms and establishment of denitrifying conditions. Beside location options, design options include choice of subsurface versus surface systems. In subsurface systems contact of water with

substrates (for carbon supply and surface area for growth of denitrifying bacteria) is maximized. On the other side, water volume in surface wetlands is usually higher enabling higher retention times at same sized systems. Results of monitoring give indications for slightly better performance of the ditch compared to wetlands.

Further advice for implementation of new systems for mitigation of diffuse nitrate pollution

In order to optimize retention in newly built sites, following further design considerations should be done (see also Table 1):

- Information to be gathered before design: topography (e.g. slope), water quality and quantity, soil characteristics.
- Filter conditions should be respected and any impermeable layer within infiltration material should be avoided
- In surface flow system, HRT should be maximized by forcing a long water pathway (e.g. meander-shape) and avoid preferential flow through the basin. For this high and stable embankments may be added.
- Each material added to a construction site should be tested and registered before use (ex: how much fine in gravels, release of P and N from amended soil ...)
- Inspection should be regularly done: after major rain events, every season (every month for monitored sites)
- Maintenance needs include
 - o Removal of sediments in settling shaft when >50% of shaft volume filled
 - o Replacement of carbon sources (interval dependent on substrate)
 - o Cleaning of inflow grids
 - o Grass mowing if landscape function is desired
 - o Removing of trees that grow within infiltration layers
 - o Repair or replacement of damaged features
- Organization and maintenance
 - o If different partners manage the sites, cooperation should be maximized

Experiences and recommendations from problems encountered during monitoring

During the monitoring a number of problems occurred and the following experiences were made. Damage of wooden weirs by animals such as water rats can be prevented by change of material (e.g. metal). Furthermore, metal mesh on the inflow pipes can prevent these animals entering the pipes and manholes from the system side. Weirs need to be installed and sealed carefully to prevent leakage, which was a repeated problem at all three systems. For quick and easy estimation of real inflows and outflows, hand measurements of flows by measuring time to fill a 10L bucket have proven to give valuable data that can also be used to validate measured flow data. Finally, measurement of water level in basins (e.g. surface basin) by ultrasonic level sensors (installed above water surface) should be installed in a way that interference with aqueous plants is avoided (e.g. by installation within plastic pipe).

Appendices

Appendix A - Original Sites design

Appendix B - Adaptation of original designs

Appendix C - Instrumentation

Appendix D - Water quality parameters measurements

Appendix E - Precipitation analysis and resulting storage volume

Appendix F - Valves Manipulation in infiltration ditch

Appendix G - Results tracer tests

Appendix H - Additional hydrologic results

Appendix I - Additional water quality results

Appendix J - Weekly averages for flow and nitrate reduction

Appendix K - Raw Monitoring results

Appendix A. Original Sites design

Infiltration Ditch

Legend:

- New —
- Old ground —
- Water level effluent —
- infiltrant —
- overflow —

Top view effluent

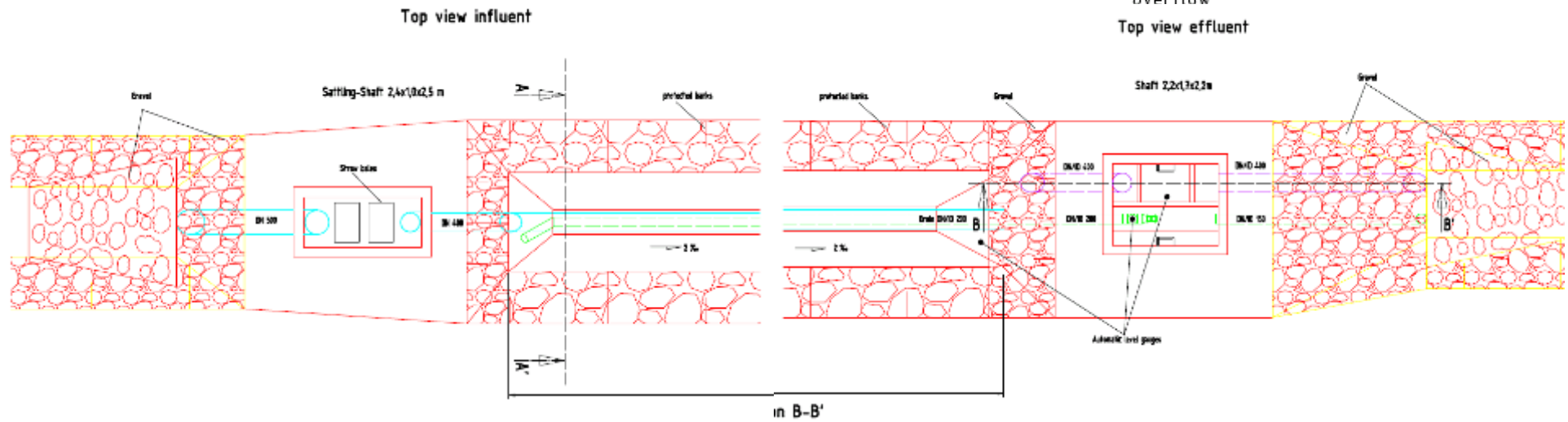

Cross section A-A'

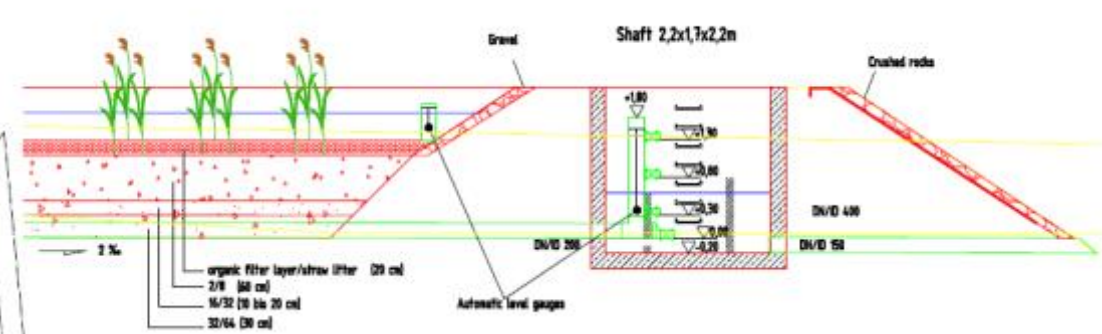
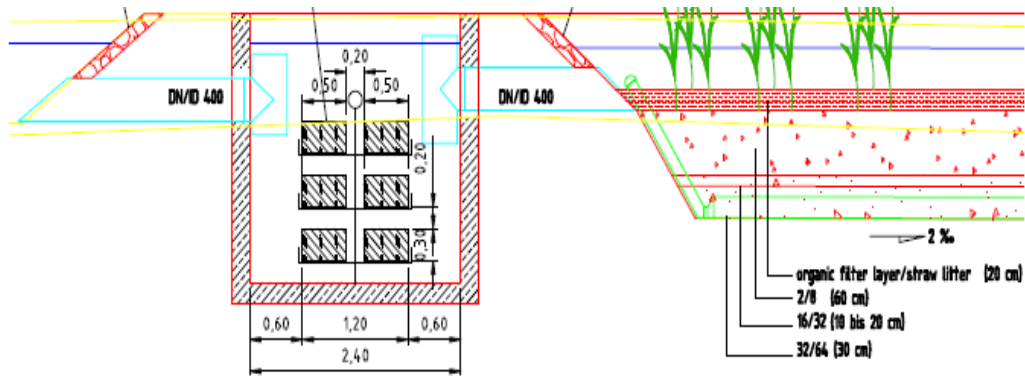
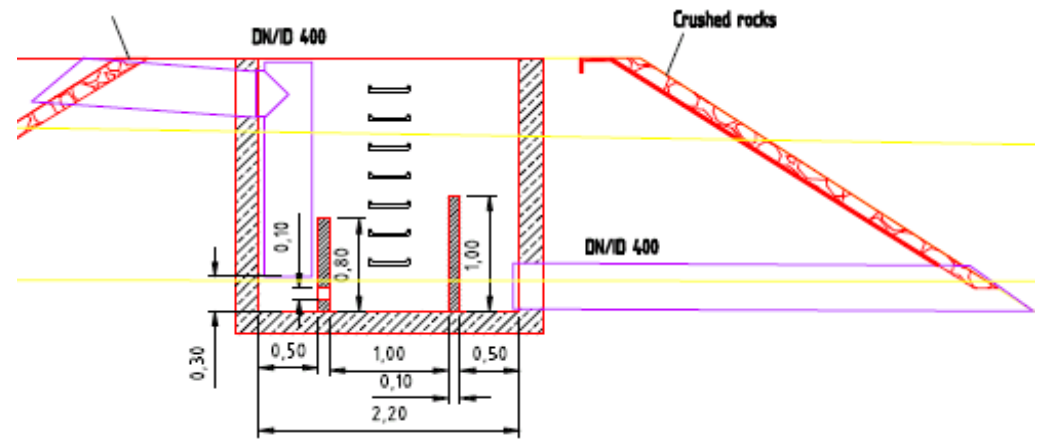
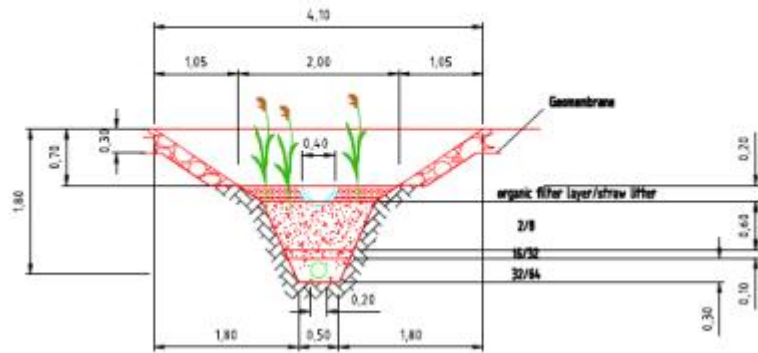

Infiltration Basin

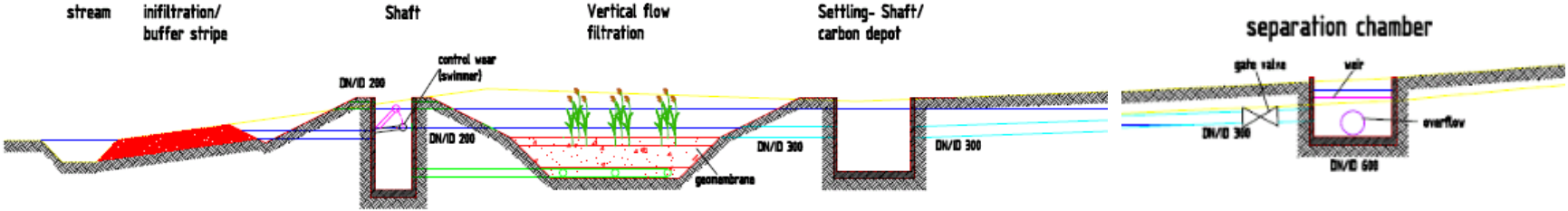
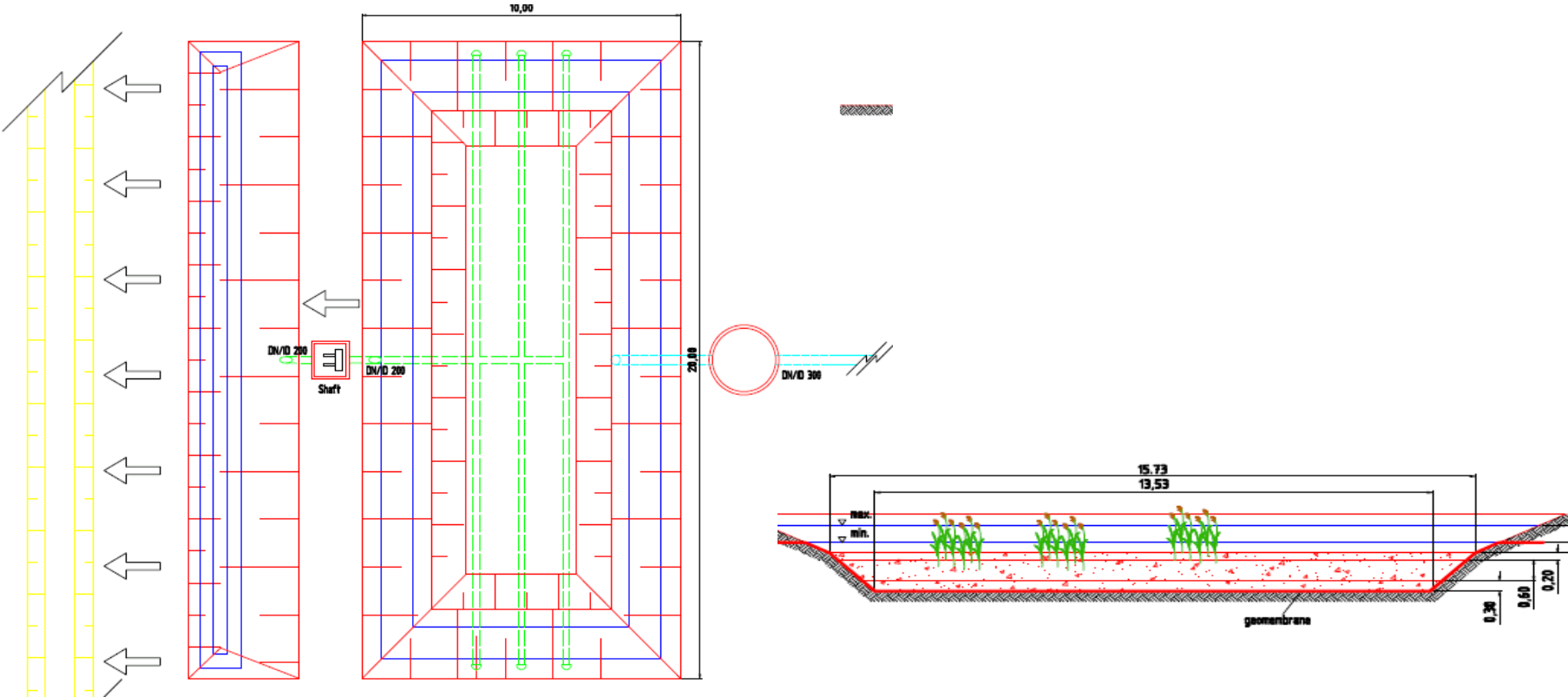

Surface Basin

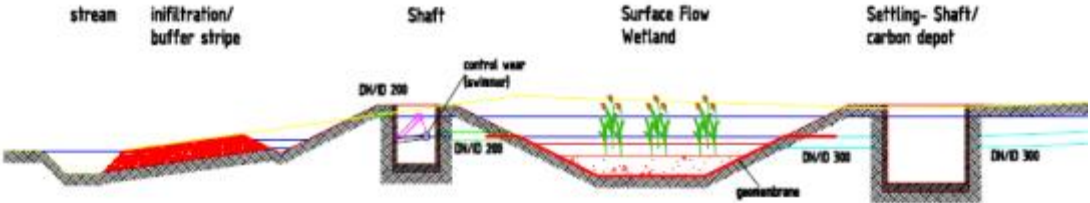
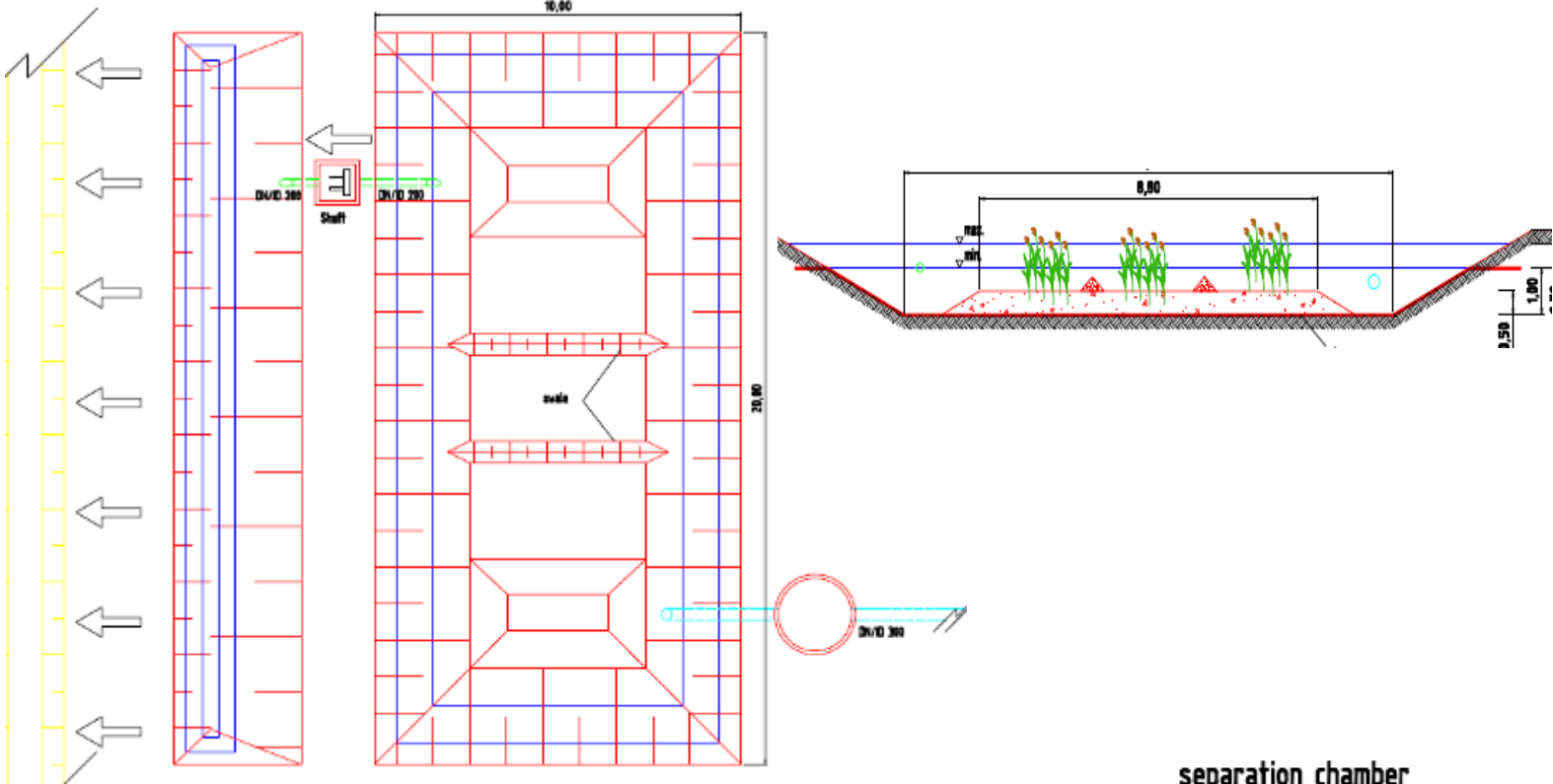

separation chamber

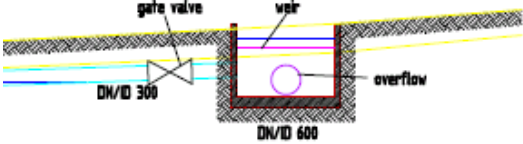





Appendix B. Adaptation of original designs

Construction	Compartment	Element	Change	Reason
Infiltration ditch	Inflow shaft (C-shaft)	Dimensions	Bigger shaft, different shape	Available material
		Straw cages	One single cage inserted	Available material, management simplification
	Ditch	Slope	Bottom slope : 2% Surface slope : 1% or less	Error during construction
		Gravel dimensions	Bigger granulometry	Clogging prevention
		Top layers	A gravel layer is added at the top	Stabilization of organic material, improving wet conditions
		Surface configuration	Inflow on one point, batardeaux are added	Increase of water storage in case of overflowing
	Outflow shafts	Shafts	2 shafts instead of one	Available material
		Weirs	In each outflow shaft, only one weir	Measurement material needs







Construction	Compartment	Element	Change	Reason
Basins	Separation chamber	Gate valve	Does not exist	No need: water level at the inflow is determined by weirs in each wetland inflow chamber
Infiltration basin	Wetland	Configuration	Inflow at one corner, outflows at an other corner	Terrain configuration, longer pathway
		Layers	Thin intermediate layer has been added	Filter conditions are respected
		Geomembrane	Some of it is installed between fine gravel layer and organic mix	Error during construction
	Outflow	Shaft	Drain outflow follows the same system as infiltration ditch	Possibility to manage water level, separation of surface and subsurface outflow
		Infiltration strip	Local soil separate drain outflow and the river: there is very little infiltration	Proximity of the river, legal restrictions
Surface basin	Wetland	Geomembrane	No geomembrane has been used	Local soil was impermeable enough
		Configuration	The whole wetland length is covered with soil	Simplifying construction
		Banks	3 banks on the whole width have been constructed	Retain more water in the wetland compartments
	Outflow	Shaft	No shaft has been constructed	No need for chemical monitoring
		Infiltration stripe	Local soil separate drain outflow and the river: there is very low infiltration	Proximity of the river, legal restrictions

Appendix C. Instrumentation

Infiltration ditch

Measuring point	B1: Ditch inflow	C1.2: around 10m from outflow	D1: Drain outflow	E1: Overflow
Sensor	Continuous flow-level meter and level meter	Continuous pressure sensor	Continuous level meter	Continuous level meter
Model	2150 ISCO and M0111501 (Ijinus)	PONSTS 32 (Ponsel)	M0111501 (Ijinus)	M0111501 (Ijinus)
Technology	Doppler / ultrasonic level	Differential pressure sensor	Ultrasonic numerical level probe	Ultrasonic numerical level probe
Values range	0,2 to 3m (velocity: from 0,025m/s)	0,1 to 2 bar	0,2 to 3m	0,2 to 3m
Date of first installation	05.02.2010	22.12.2010	22.12.2010	06.01.2011
Associated installation	Outflow pipe	Piezometer	Weir	Weir
Picture				
	Calibration: one flow hand measurement at the installation Validation: regularly during monitoring			

Basins

Measuring point	H6.1 I.Basin inflow	H6.2 S. Basin inflow	J6 Drain outflow	I6.1 I.Basin Overflow	I6.2 S. Basin Overflow	K6 Next to I. Basin
Sensor	Continuous pressure sensor	Continuous pressure sensor	Continuous pressure sensor	Continuous level meter	Continuous level meter	Continuous pressure sensor
Model	PONSTS 32 (Ponsel)	PONSTS 32	PONSTS 32	M0111501 (Ijinus)	M0111501 (Ijinus)	PONSTS 32
Technology	(see above)	(see above)	(see above)	(see above)	(see above)	(see above)
Values range	0,1 to 2 bar	0,1 to 2 bar	0,1 to 2 bar	0,2 to 3m	0,2 to 3m	0,1 to 2 bar
Date of first installation	14.12.2010	14.12.2010	14.12.'10, Modified in Dec 2012	12.01.2012	06.01.2011	22.12.2010
Associated installation	Weir	Weir	Weir with adjustable height	Weir	Weir	Piezometer
Picture						
	Calibration: one flow+level hand measurement at the installation Validation: regularly during monitoring					

Appendix D. Water quality parameters measurements

	Parameter	sampling		Methode (in french)	Drinking/ Waste water	Detection Limit (DeL)	Max of detection	Unit	"incertitude": CAE inter-labos essais			From our databank, all results (in given Unit),			
		regul ar	auto						D/W	(mg/L)	(mg/L)	Concentr ation	%	Approach	Min
Chemical Analyses	CAE Rennes	Ammonium	X	X		D	0.02	0.2	mg- NH4/L	0.5	15	EIL	0.01	0.49	0,06
										0.02	10	PE			
		Nitrite (NO ₂)	X			D	0.02	0.3	mg- NO2/L	0.15	15		0.01	0.32	0,09
										1	10	EIL			
										0.1	20	EIL			
		Nitrate (NO ₃)	X	X		D	1	80	mg- NO3/L	30	5		6.7	85.1	50,3
										50	5	EIL			
										1	25	EIL			
		Orthophosphate (PO ₄)	X	X		D	0.025	1	mg- PO4/L	0.75	5	EIL	0.0125	1.7	0,14
										0.025	25	PE			
DOC	X			D	0.3	10	mg-C/L	2	10	PE	1.5	9.9	2,76		
								10	5	PE					
								0.3	20	PE					
NTK*	X	X		W	2		mg-N/L	20	5		1	2	1,02		
NTK filter*	X			W	2		mg-N/L	20	5		1	1	1,00		
								2	40						
Total P	X	X		W	0.1		mg-P/L	2.3	10		0.05	0.86	0,11		
								0.1	10						

Manual Measurements	Probe	Precision												
		Temperature	X			-5	70	°C		0.2	°C	5.6	10.3	7.61
		Conductivity	X		Cellule 4 électrodes	0	200	mS/cm		0.5	%	212	426.1	251.94
		Redox	X		Bouton Platine	-1999	1999	mV		20	mV	60	219.6	175.25
		O ₂	X		Polarographique ou galvanique	0	50	mg-O ₂ /L	0 - 20	2	%	0.7	15.6	8.76
						20 - 50	6		%					
		O ₂ % saturation	X			0	500	%	0 - 200	2	%	5	133	77.76
								200-500	6	%				
		NO ₃ Probe*	X		Electrode Ion Spécifique	0	200	mg-N/L		10	%	10.3	48.7	35.16

* NTK/NTK_f only measured in 2011

Uncertainty from CAE laboratory (fr)

EIL: Essai interlaboratoire: the same sample is analyzed in all CAE laboratories, the results variations are represented

PE: Plans d'Expérience: based on real matrix, in intermediate fidelity control

Values under detection limit (DL)

In the database they are indicated as DL/2 (usual convention); in the above table in light blue. Mean values have been calculated with those half-DeL values.

Manual measurements

Some measures require more time to stabilize (Redox, NO₃) and some require precautions related to aeration during the measurement (O₂, Redox).

Appendix E. Precipitation analysis and resulting storage volume

In order to evaluate needed volume for retention system, following steps were done by the engineering office AKUT:

1. Rain data are gathered for a long period (from beginning of 1996 to middle of 2006)
2. The sum of rain values are calculated for 7-days periods
3. It is considered that periods with less than 20 mm precipitation in 7 days do not cause flowing: they were disregarded
4. It is considered that 55% of the rain water will cause stream flowing; we obtain a contribution to flow, in mm/7d
5. Which value represents 90% of the obtained values?
6. The last identified value is multiplied by the catchment area. The result, in mm.ha is to be adapted in m³, this represents the volume to be retained by the mitigation system in order to have a 7 day hydraulic buffer effect

Table 11: Comparison of needed volume for a retention of 7days (from a table by AKUT), designed volume (by AKUT) and estimated actual volume of water contained during the 2010-2011 season

Site	Catchment (ha)	Needed Volume (m ³)	Designed Volume (m ³)	Measured volume (m ³)
Ditch	8,5	2608	20,9	20
Wetlands	6	1840	181,2	108

Appendix F. Valves Manipulation in infiltration ditch

Porous volume of the infiltration ditch material can be calculated by measuring the time of filling of the empty ditch after closing drain outflow valves. A piezometer monitored within the ditch next to outflow enables to verify saturation level (controlled by drain outflow valves).

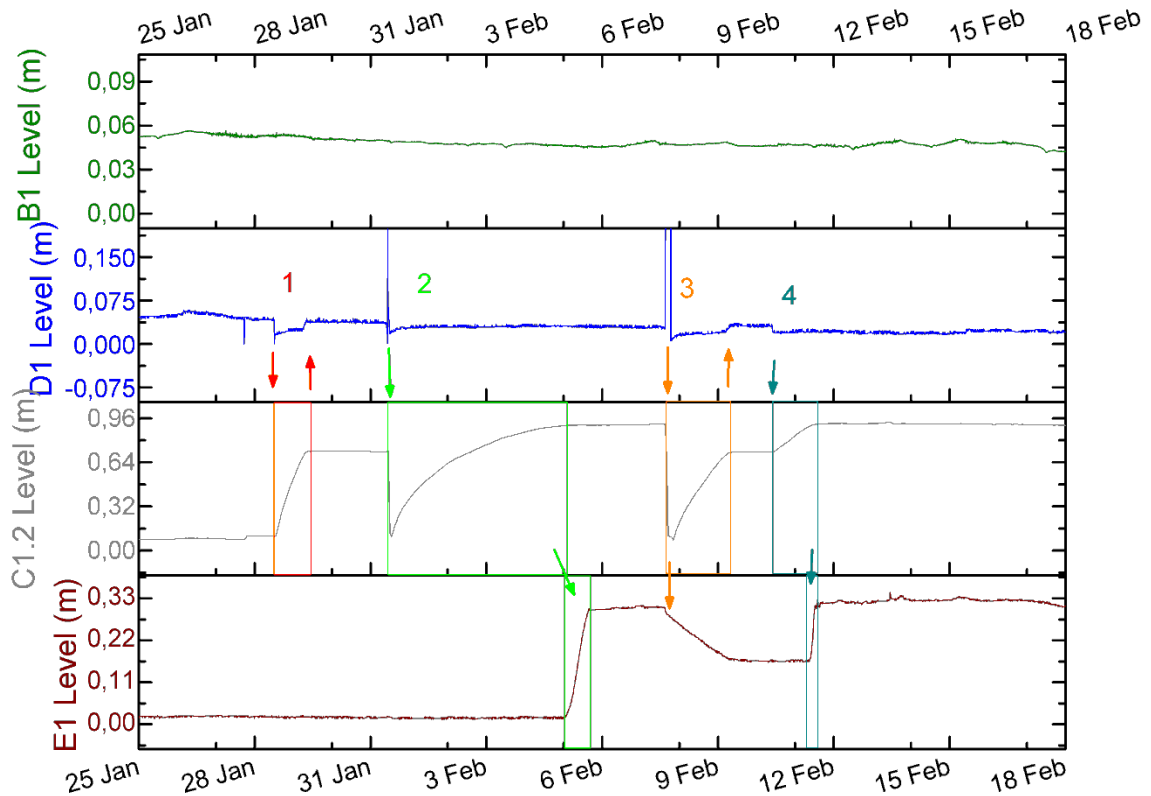

The 4 identified events were caused by actions on drain valves (in D1), with impact on water level within the swale (measured in C1.2), drain overflow (D1) and sometimes overflow (E1).

Until the first event, all drain outlets are open, water level within the system is low; it is measured in the piezometer: $L_0 = 0.08\text{m}$

1. Event (in red):

28.01, 12:15: Installation of the drain outflow valves, closing of the bottom one. This manipulation causes a sharp decrease in inflowing water in drain shaft (D1).

→ C1.2. Without outflow from the system, the ditch fills with water until the level of the second valve: $L_2 = 0.72\text{ m}$. Filling time for this volume of the ditch was $T_1 = 210\text{min}$ (3h30).

→ D1. Water level within the ditch reaches the level of the second valve.

2. Event (green):

31.01, 10:35 Opening of the bottom drain valves, then closing of both valves.

→ C1.2. The ditch is nearly completely emptied and then saturated until overflow level $L_3 = 0.91\text{ m}$. Time of (nearly complete) ditch saturation is $T_2 = 1090\text{ min}$ (18h10).

→ E1. Overflowing water begins to fill into the overflow shaft, until the weir level (0.300 m). After this event all inflowing water should flow out to overflow shaft.

3. Event (orange):

07.02, 15:00 to 19:00: Re-opening of the two drain valves for repairing, and closing of the bottom one.

After all the first flow passed through the drain outflow, level in D1 reaches its lower value.

→ C1.2. Emptying of the ditch (L0), then filling until level L2. Filling time: T3 = 360 min (6h)

→ E1. Overflow stops during this event

→ D1. When L2 reached in the ditch, water flows out of the system through the drain.

4. Event (blue-green):

10.02, 9:45: Closing of the second drain valve. No water flows through the drain shaft.

→ C1.2. Filling of the ditch until level L3; T4 = 270 min (4h30)

→ E1. Overflow

Comparison of the filling times

Comparison of inflow level and filling time for the 4 valve manipulation events

	T1	T2	T3	T4
Level Beginning	L0	L0	L0	L2
Level End	L2	L3	L2	L3
Time (min)	2010	1090	360	270
Mean Inflow L (m)	0,053	0,048	0,047	0,047
Mean Inflow Q *(m ³ /s)	2,76	1,57	1,11	0,93

* calculated using Poleni Flow calculation

We observed that: T1>T3 and T2 > T3+T4

While inflow decreases slightly, filling time of the ditch decreases. This may be due to the leaks observed at drain outflow and repaired after 2nd event. We can thus not use the two first events for any further calculations.

Porous Volume Calculation

It is considered that during filling events there is either outflow or further inflow (no rain was measured at this date and leakages or lateral inflows are not considered)

$V_{0-2}=T3*Q3 =6,7 \text{ m}^3$ Volume between lowest saturation level and second valve level

$V_{2-3}=T3*Q4 =4,2 \text{ m}^3$

$V_{0-3}=V_{0-2}+V_{2-3}=10,9 \text{ m}^3$ Volume of water between lowest and highest saturation level

Porous volume at lowest saturation level is estimated at around 2 m³ (for a depth at piezometer of 0,2m of drain pipe+rocks and 0,1m of gravels).

Total porous volume at saturated condition is then estimated at 12,9 m³ .

Appendix G. Results tracer tests

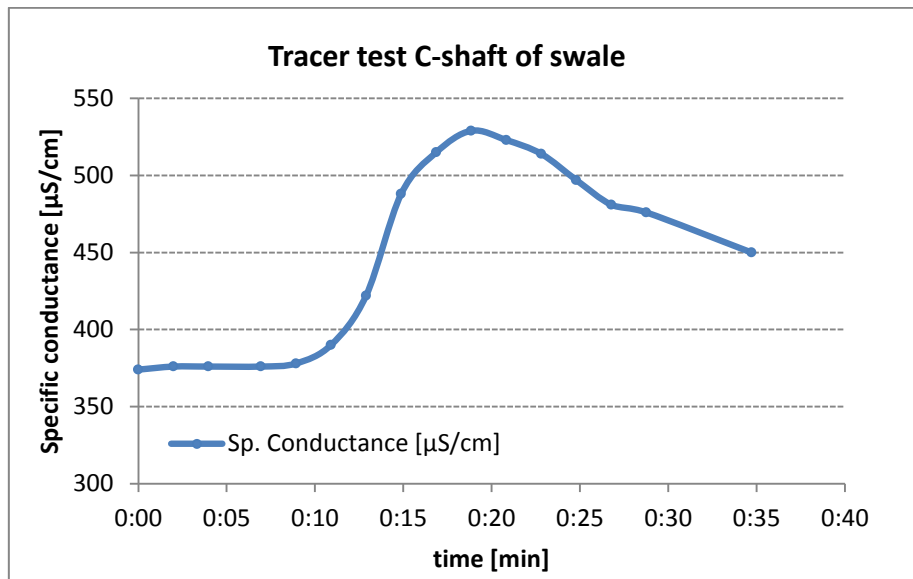

Figure 40: Measured conductivity at outlet of C-shaft of infiltration ditch after addition of saturated salt solution to inlet (B1).

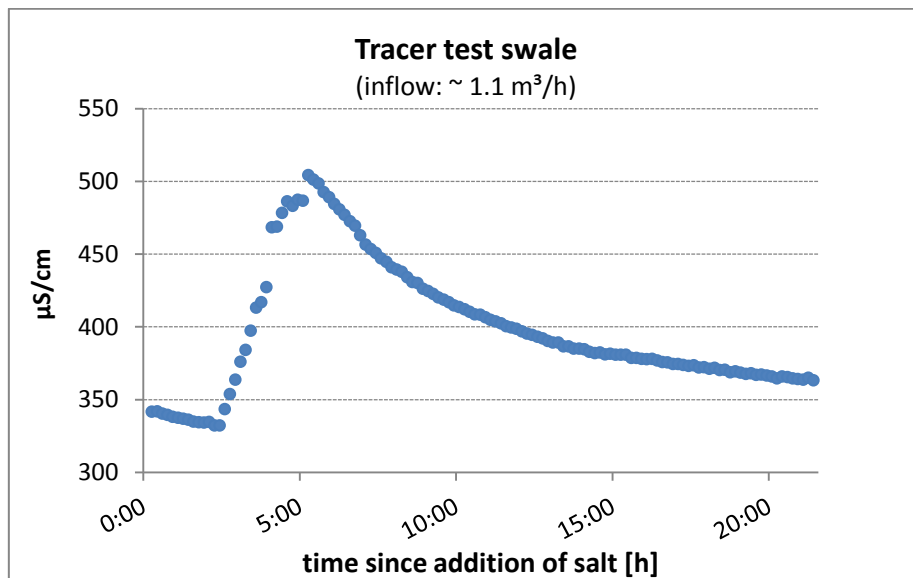

Figure 41: Measured conductivity at outlet of infiltration ditch after addition of saturated salt solution to inlet (B1) at inflow of $1.1 \text{ m}^3/\text{h}$ in May 2013.

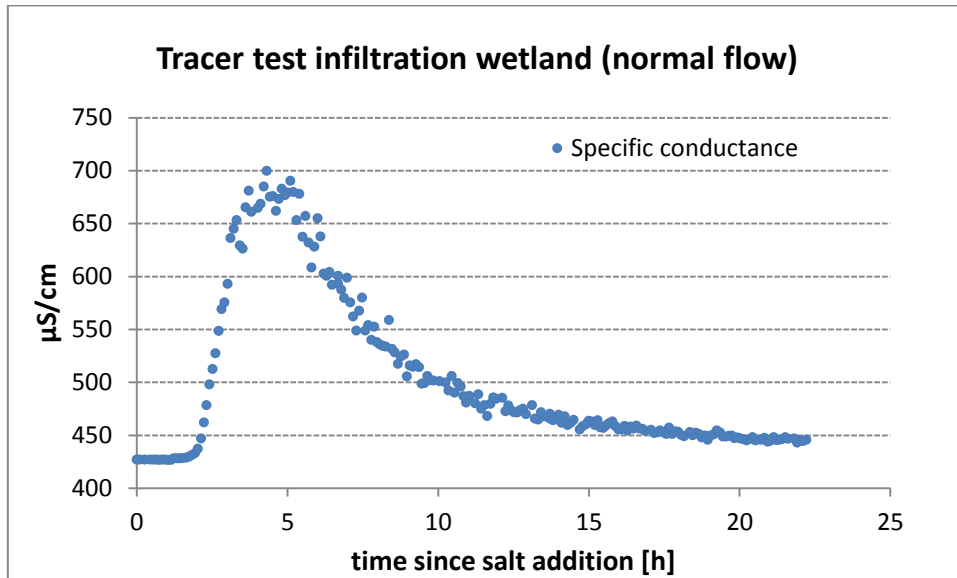

Figure 42: Measured conductivity at outlet of infiltration wetland (J6) after addition of saturated salt solution to inlet (H6.1) at inflow of $3.1 \text{ m}^3/\text{h}$ in February 2013.

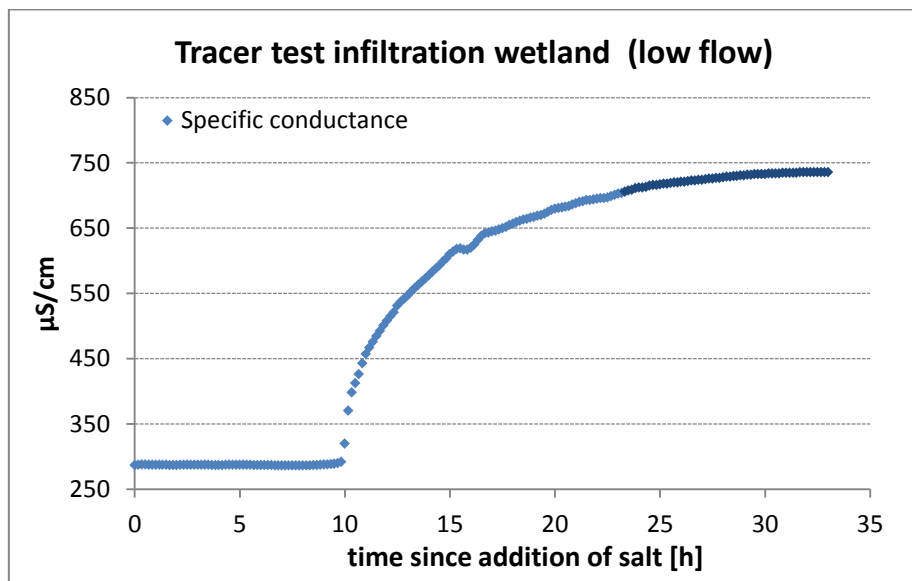

Figure 43: Measured conductivity at outlet of infiltration wetland (J6) after addition of saturated salt solution to inlet (H6.1) at inflow of $0.22 \text{ m}^3/\text{h}$ in May 2013.

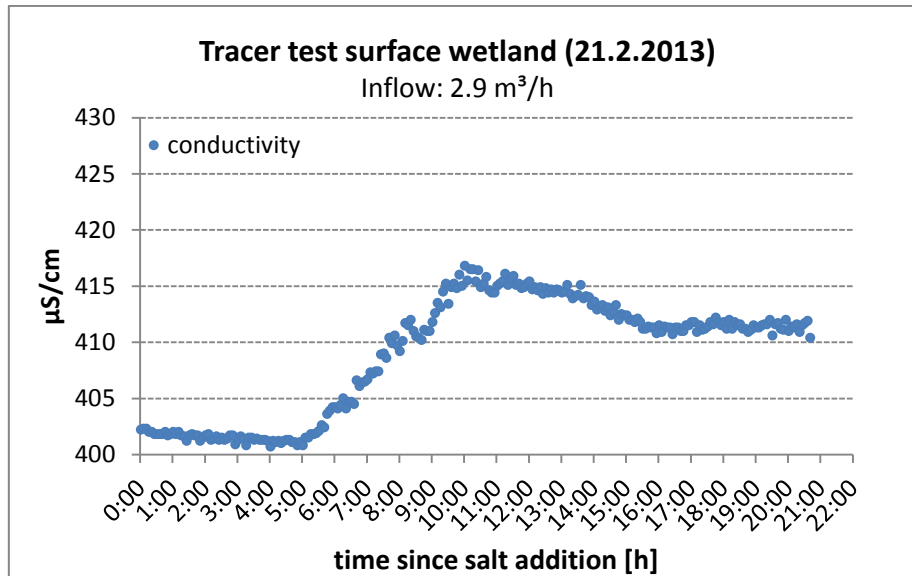

Figure 44: Measured conductivity at outlet of surface wetland (I6.2) after addition of saturated salt solution to inlet (H6.2) at inflow of 2.9 m³/h on 21. February 2013. Addition of saturated salt solution resulted in a more pronounced dilution due to the free water body leading to an increase of conductivity by only 15 µS/cm (~250 µS/cm in infiltration wetland).

Table 12: Results of tracer experiments and resulting relationships between inflow and HRT

Ditch incl. C-shaft (drain valve closed)

estimated saturated volume: 12.9 m³

	inflow [m ³ /h]	HRT [h]	volume [m ³]	hydraulic efficiency
21 February 2013	6.1	1.6	10.0	77%
05 May 2013	1.1	7.1	7.9	61%

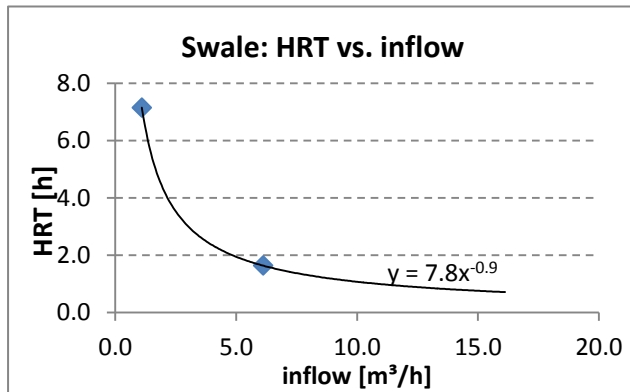

$$\text{HRT [h]} = 7.8 / (\text{inflow [m}^3/\text{h]})^{0.9}$$

Infiltration wetland

estimated saturated volume: 48m³

	inflow [m ³ /h]	HRT [h]	volume [m ³]	hydraulic efficiency
Feb 2013	3.1	4.7	14.4	30%
May 2013	0.22	33	7.1	15%

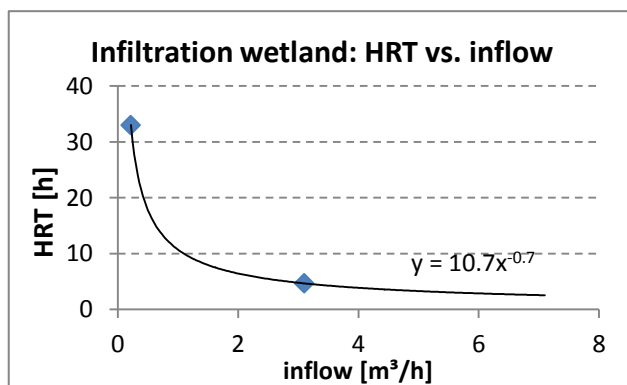

$$\text{HRT [h]} = 10.7 / (\text{inflow [m}^3/\text{h]})^{0.7}$$

Surface wetland

estimated saturated volume: 60m³

	inflow [m ³ /h]	HRT [h]	volume [m ³]	hydraulic efficiency
Feb 2013	2.9	10.0	29.0	48%
May 2013	n.d.	n.d.	n.d.	

$$\text{HRT [h]} = 29 / \text{inflow [m}^3/\text{h]}$$

Appendix H. Additional hydrologic results

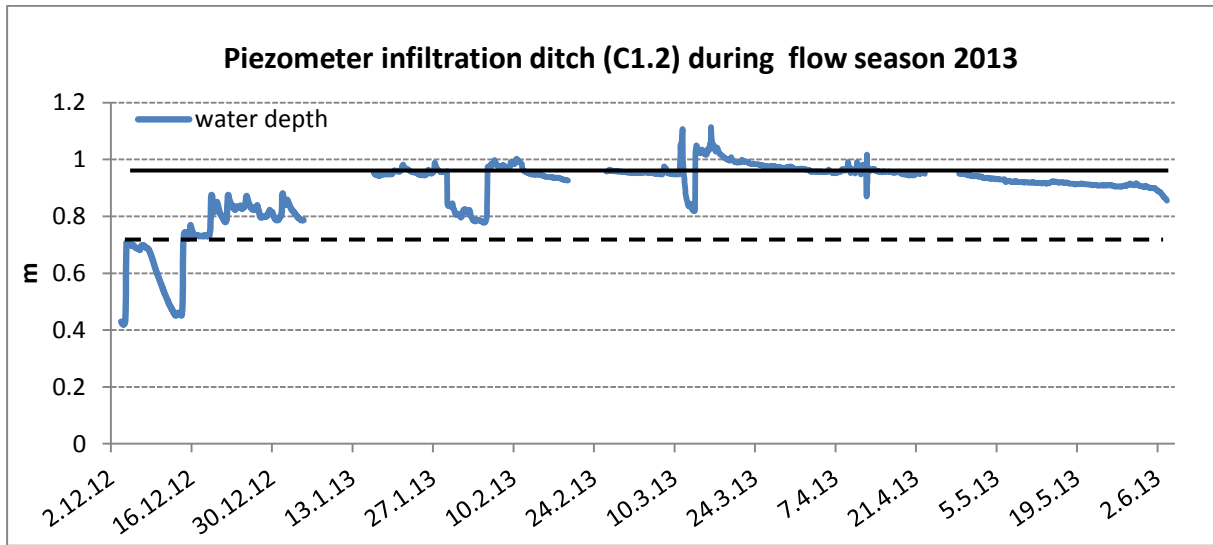

Figure 45: Water level in infiltration ditch as measured by piezometer at monitoring point C1.2 (black line: water level at overflow, dashed line: water level with open upper drain valve = 10 cm below surface).

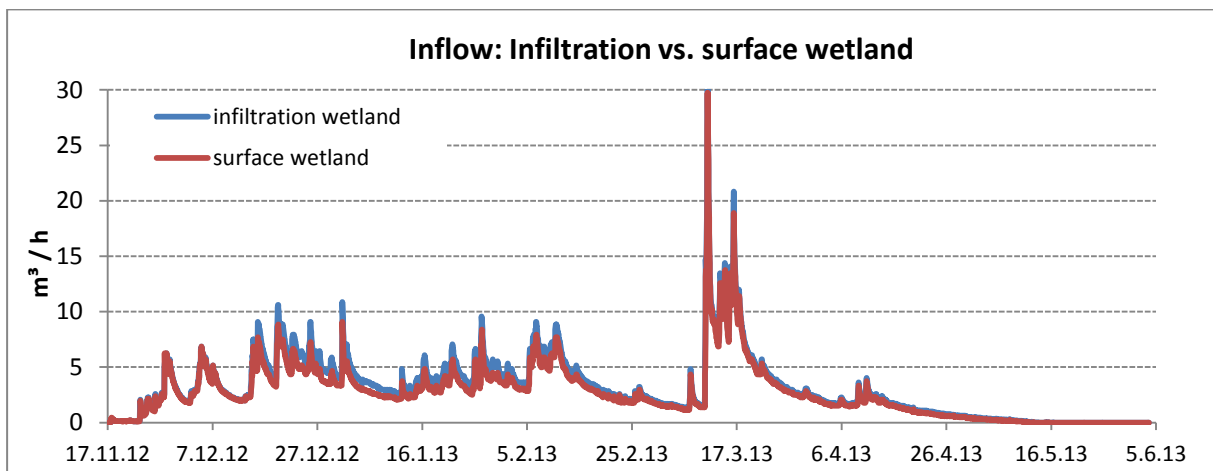

Figure 46: Comparison of inflow to surface and infiltration wetland. Little differences between mid-December and mid-February are likely due to placement of straw bag into separation chamber in order to increase carbon input into wetlands. Bag was removed in February 2013.

Appendix I. Additional water quality results

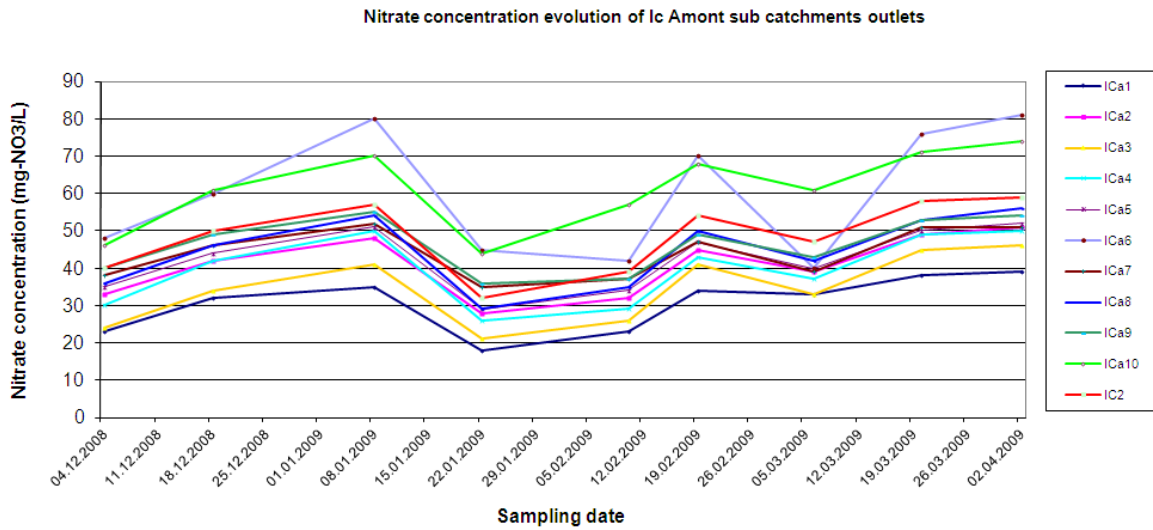

Figure 47: Nitrate concentration (in mg-NO₃/L) at Ic Amont outlet (IC2) and 10 subcatchments of Ic-Amont. Infiltration ditch is situated in Ica8 and the basins in Ica5, which are relatively extended subcatchments (source: SMEGA)

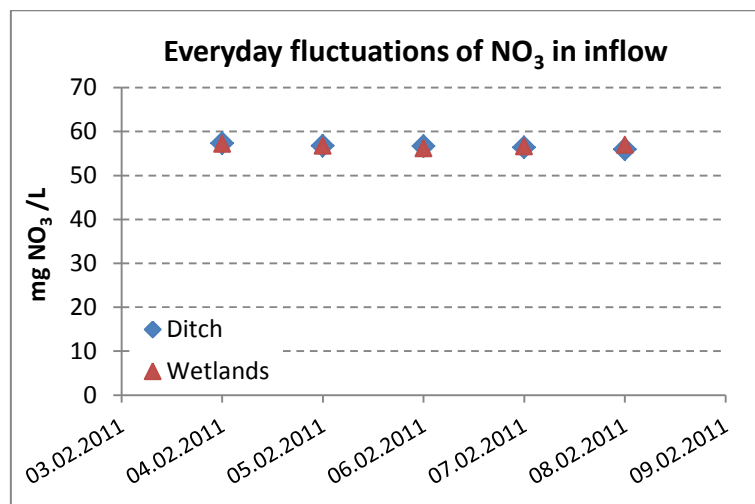

Figure 48: Everyday inflow fluctuations of NO₃ of ditch and wetlands during 5 day autosampler campaign.

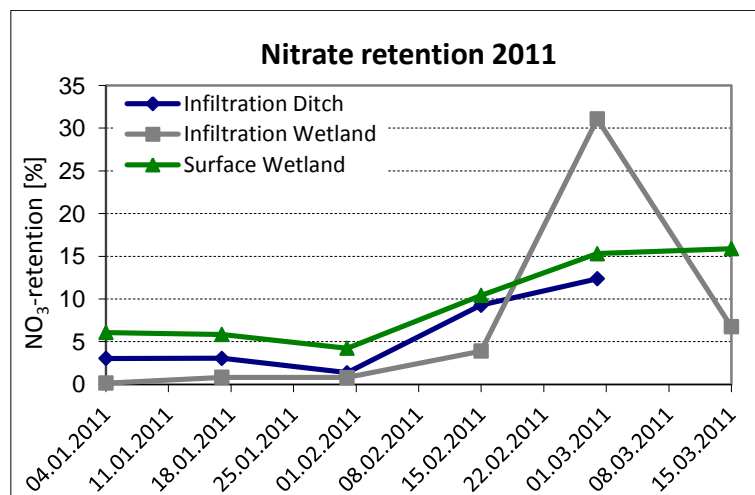

Figure 49: Nitrate retention during flow season 2011.

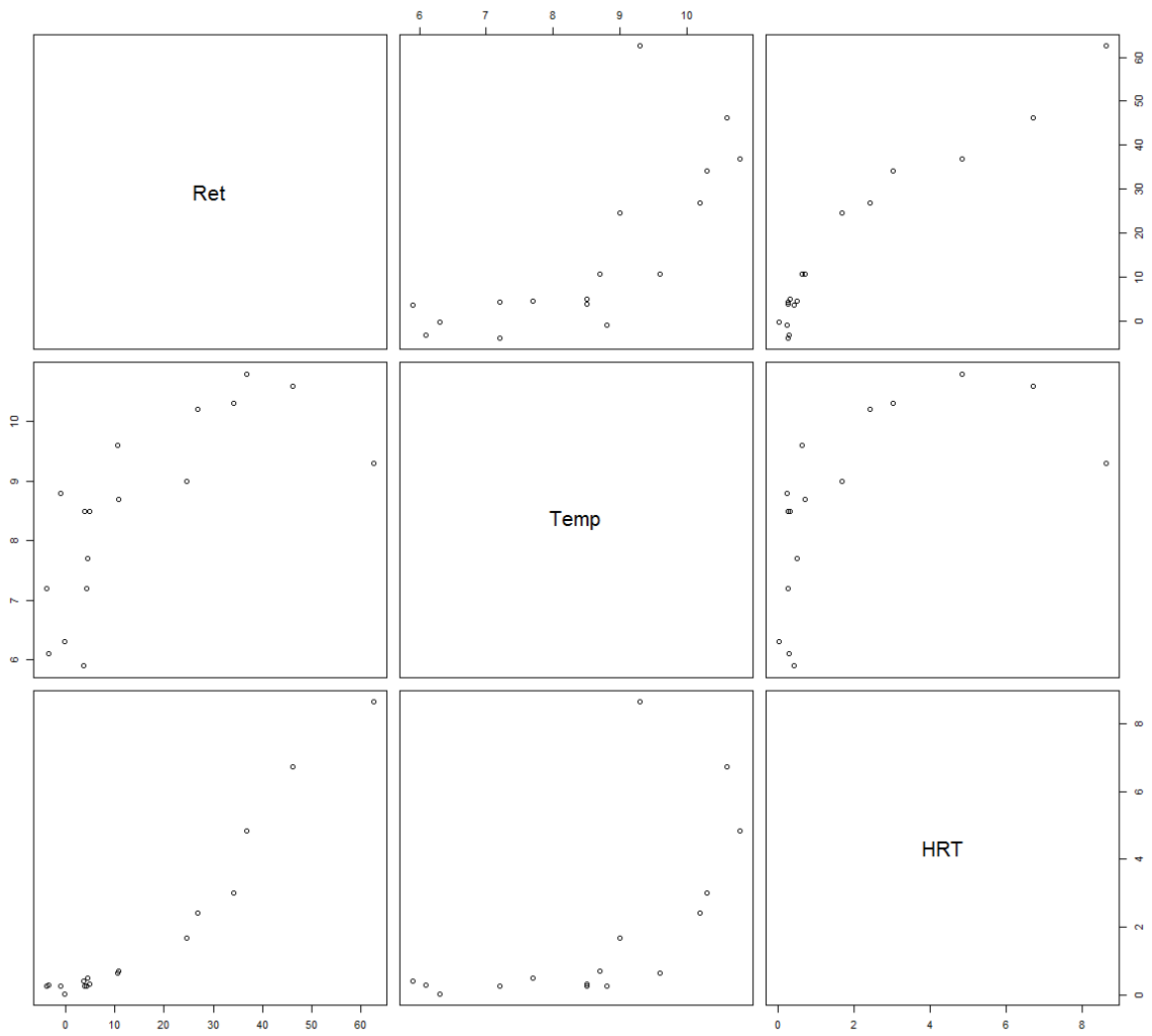

Figure 50: Linear multi regression plot between nitrate retention (Ret), temperature (Temp) and HRT exemplarily for surface wetland.

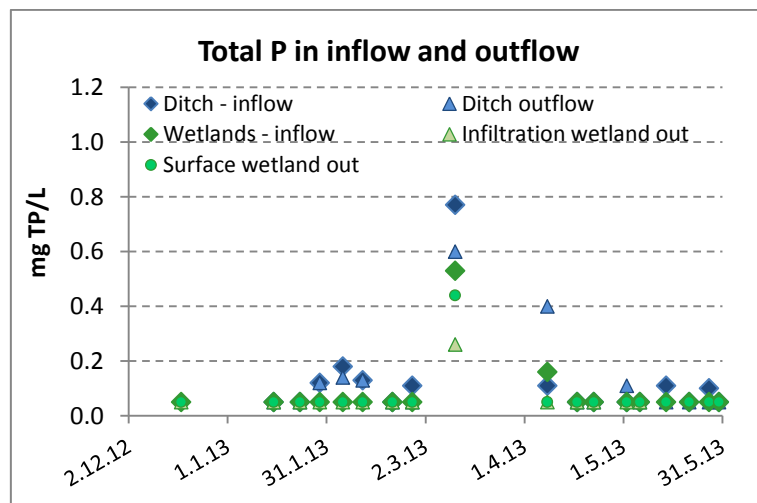

Figure 51: Total P in inflow and outflow of all systems during flow season 2013.

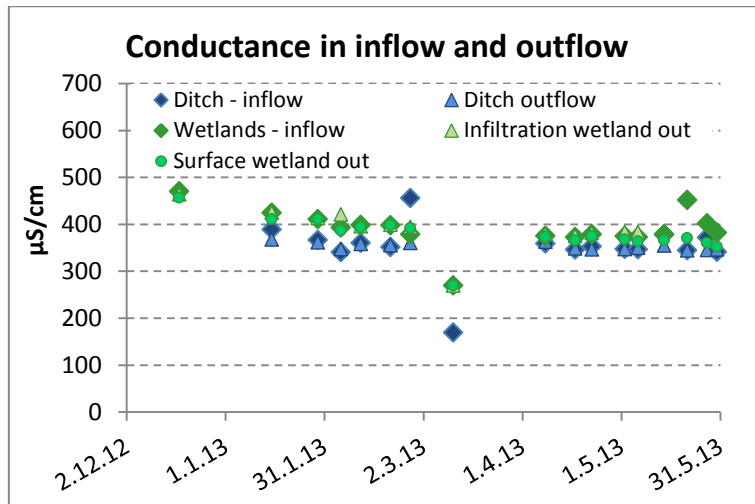

Figure 52: Specific conductance in inflow and outflow of all three systems during flow season 2013.

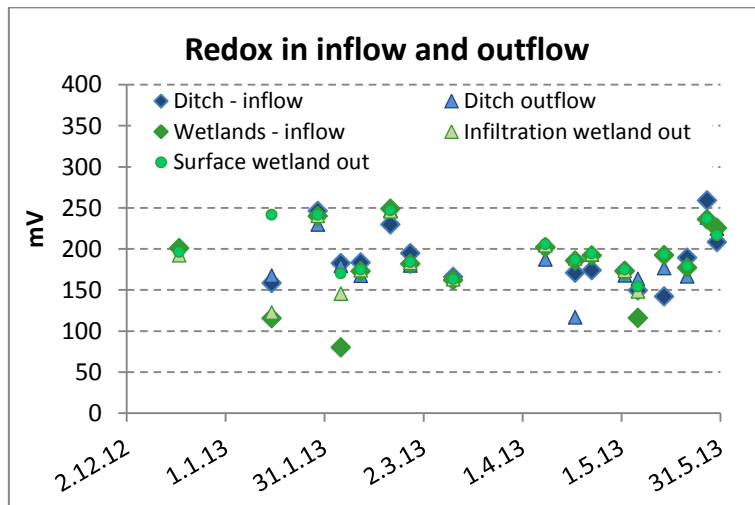

Figure 53: Redox potentials in inflow and outflow of all three systems during flow season 2013.

Appendix J. Weekly averages for flow and nitrate reduction

Table 13: Weekly averages of flow, HRT, relative NO₃-reduction, load reduction and inflow load for infiltration ditch (from 21.2., closure of drain valve, values from ditch outflow E1 were used for determination of weekly averages due to higher accuracy (outflow=inflow)).

KW	qAvg	HRT	NO3 reduction	Load reduction	NO3 load inflow
	[m ³ /h]	[d]	[%]	[kg/week]	[kg/week]
2012_KW_50	2.39	0.148	4.1%	0.84	20.5
2012_KW_51	7.6	0.052	1.4%	0.94	65.2
2012_KW_52	9.43	0.043	1.2%	0.96	80.9
2012_KW_53	9.02	0.045	1.2%	0.96	77.4
2013_KW_01	8.68	0.046	1.3%	0.95	74.4
2013_KW_02	7.81	0.051	1.4%	0.94	67.0
2013_KW_03	9.22	0.044	1.2%	0.96	79.1
2013_KW_04	13.24	0.032	0.9%	1.00	113.6
2013_KW_05	12.12	0.034	0.9%	0.99	104.0
2013_KW_06	15.8	0.027	0.7%	1.01	135.5
2013_KW_07	16.38	0.026	0.7%	1.02	140.5
2013_KW_08	7.37	0.054	1.5%	0.94	63.2
2013_KW_09	6.36	0.061	1.7%	0.93	54.5
2013_KW_10	5.47	0.070	1.9%	0.91	46.9
2013_KW_11	27.24	0.017	0.5%	1.07	56.3
2013_KW_12	29.01	0.016	0.4%	1.08	59.9
2013_KW_13	13.29	0.032	0.9%	1.00	114.0
2013_KW_14	7.3	0.054	1.5%	0.94	62.6
2013_KW_15	6.61	0.059	1.6%	0.93	56.7
2013_KW_16	4.12	0.091	2.5%	0.89	35.3
2013_KW_17	2.45	0.145	4.0%	0.84	21.0
2013_KW_18	1.57	0.217	6.0%	0.80	13.5
2013_KW_19	1.12	0.293	8.1%	0.78	9.6
2013_KW_20	0.79	0.402	11.1%	0.75	6.8
2013_KW_21	0.41	0.725	20.0%	0.70	3.5
2013_KW_22	0.25	1.132	31.2%	0.67	2.1
Average	9.27	0.044	Sum [kg NO3]:	23.8	1564

1.5%

Table 14: Weekly averages of flow, HRT, relative NO₃-reduction, load reduction and inflow load for infiltration wetland.

KW	qAvg	HRT	NO3 reduction	Load reduction	NO3 load inflow
	[m ³ /h]	[d]	[%]	[kg/week]	[kg/week]
2012_KW_48	2.9	0.21	2.6%	0.69	27.0
2012_KW_49	3.8	0.17	1.6%	0.59	35.8
2012_KW_50	3.4	0.19	2.1%	0.64	31.3
2012_KW_51	6.5	0.12	0.3%	0.20	60.5
2012_KW_52	5.8	0.13	0.6%	0.31	53.9
2012_KW_53	5.1	0.14	0.9%	0.41	47.6
2013_KW_01	4.6	0.15	1.1%	0.49	42.9
2013_KW_02	3.0	0.20	2.4%	0.68	28.5
2013_KW_03	3.7	0.18	1.7%	0.60	35.0
2013_KW_04	4.6	0.15	1.1%	0.48	43.3
2013_KW_05	5.0	0.14	0.9%	0.43	46.6
2013_KW_06	5.6	0.13	0.7%	0.34	52.2
2013_KW_07	5.2	0.14	0.8%	0.39	49.0
2013_KW_08	2.7	0.22	2.8%	0.71	25.2
2013_KW_09	2.2	0.26	3.7%	0.75	20.3
2013_KW_10	1.8	0.30	4.7%	0.77	16.5
2013_KW_11	10.8	0.08	-0.5%	-0.55	67.4
2013_KW_12	6.2	0.13	0.4%	0.25	57.4
2013_KW_13	3.1	0.20	2.4%	0.67	28.5
2013_KW_14	2.0	0.28	4.1%	0.76	18.6
2013_KW_15	2.3	0.25	3.5%	0.74	21.4
2013_KW_16	1.5	0.33	5.5%	0.78	14.1
2013_KW_17	0.9	0.49	9.3%	0.76	8.2
2013_KW_18	0.5	0.75	15.7%	0.70	4.4
2013_KW_19	0.2	1.35	30.3%	0.58	1.9
Average	4.02	0.18	Sum [kg NO3]:	13.2	837

1.6%

Table 15: Weekly averages of flow, HRT, relative NO₃-reduction, load reduction and inflow load for surface wetland.

KW	qAvg	HRT	NO3 reduction	Load reduction	NO3 load inflow
	[m ³ /h]	[d]	[%]	[kg/week]	[kg/week]
2012_KW_48	2.8	0.43	3.3%	0.87	26.1
2012_KW_49	3.7	0.33	2.5%	0.87	34.6
2012_KW_50	3.0	0.40	3.1%	0.87	28.4
2012_KW_51	5.4	0.22	1.7%	0.87	50.7
2012_KW_52	4.6	0.26	2.0%	0.87	42.8
2012_KW_53	4.0	0.30	2.3%	0.87	37.8
2013_KW_01	3.6	0.33	2.6%	0.87	34.0
2013_KW_02	2.4	0.50	3.9%	0.87	22.6
2013_KW_03	3.0	0.41	3.1%	0.87	27.8
2013_KW_04	3.7	0.33	2.5%	0.87	34.6
2013_KW_05	4.1	0.29	2.3%	0.87	38.4
2013_KW_06	4.8	0.25	1.9%	0.87	44.9
2013_KW_07	4.6	0.26	2.0%	0.87	42.6
2013_KW_08	2.4	0.51	4.0%	0.87	22.0
2013_KW_09	2.0	0.62	4.8%	0.87	18.3
2013_KW_10	1.6	0.77	5.9%	0.87	14.7
2013_KW_11	10.2	0.12	0.9%	0.87	63.6
2013_KW_12	5.8	0.21	1.6%	0.87	53.8
2013_KW_13	2.8	0.43	3.4%	0.87	25.9
2013_KW_14	1.8	0.67	5.2%	0.87	16.8
2013_KW_15	2.0	0.59	4.6%	0.87	19.0
2013_KW_16	1.3	0.92	7.2%	0.87	12.2
2013_KW_17	0.7	1.72	13.3%	0.87	6.6
2013_KW_18	0.4	3.27	25.3%	0.87	3.5
2013_KW_19	0.1	8.66	67.0%	0.87	1.3
Average	3.49	0.35	Sum [kg NO3]:	21.8	723

3.0%

Appendix K. Raw Monitoring results

Table 16: Water quality in Infiltration ditch 2011 (see Figure 6 for sampling point names)

for water presence: f=flowing, s=stagnant) ; "u.d.l" = Under detection limit

Sampling point	Date	Water presence	DOC (mg-C/L)	NH ₄ (mg-NH ₄ /L)	NO ₂ (mg-NO ₂ /L)	NO ₃ (mg-NO ₃ /L)	PO ₄ (mg-PO ₄ /L)	TP (mg-P/L)	O ₂ Probe (mg/L)	O ₂ (% saturation)	Temp Probe (°C)	Conductivity (µS/cm)
A1	17.01.2011	f	3	0.07	0.2	55.7	0.04	u.d.l				
A1	31.01.2011	f	1.6	0.04	0.03	58.2	0.09	0.1	7.3		5.6	212
A1	04.02.2011	f		u.d.l		57.4	0.06	u.d.l				
A1	05.02.2011	f		u.d.l		56.8	0.23	u.d.l				
A1	06.02.2011	f		u.d.l		56.7	0.24	u.d.l				
A1	07.02.2011	f		u.d.l		56.4	0.22	u.d.l				
A1	08.02.2011	f		u.d.l		56	0.15	u.d.l				
A1	15.02.2011	s	2	0.05	0.04	55	0.14	0.1	7.5	66	7.1	229
A1	04.01.2011	f	2.4	u.d.l	u.d.l	59.1	0.08	u.d.l				
B Straw shaft	15.03.2011	s							4.4	38	7.7	248
B Straw shaft	28.03.2011	s							12.3	111	10.1	
B1	04.01.2011	f	2.2	u.d.l	0.03	57.9	0.09	u.d.l				
B1	17.01.2011	f	3.1	0.08	0.22	55.2	0.06	u.d.l				
B1	31.01.2011	f	1.6	0.05	0.05	57.8	0.09	u.d.l	6.6		5.6	213.4
B1	02.02.2011	f							6.5		8	229.4
B1	15.02.2011	f	2	0.06	0.07	54.1	0.13	u.d.l	7.6	65	6.9	226.1
B1	28.02.2011	s	6.1	0.46	0.58	30.7	0.24	0.2	5.2	43	7.7	250.6
C1.1	15.03.2011								0.7	5	7.6	244
D1	17.01.2011	f	3.2	0.07	0.2	54	0.05	u.d.l				
D1	31.01.2011	f	1.6	0.04	0.05	57.4	0.08	u.d.l	8		5.7	217
D1	15.02.2011	s	2.2	0.03	0.14	49.9	0.1	u.d.l	6.6	56	7.2	230.6
D1	04.01.2011	f	2.2	u.d.l	0.03	57.3	0.07	u.d.l				
D1	28.02.2011	f	5.6	0.07	0.41	26.9	0.15	0.1	6.6	57	8.6	254.2
D1	02.02.2011	f							6.5		7	226.8
D1v1	15.02.2011	f							7.6	65	7.1	229.5
DS Drain shaft1	15.02.2011	s							5.2	44	7.3	236
DS Drain shaft1	15.03.2011	s							6	53	8.1	276
DS Drain shaft1	28.03.2011	s							1.2	12	9.5	426.1
E1	15.02.2011	f	2.4	u.d.l	0.24	38	0.03	u.d.l	7.1	60	6.7	239.9

Table 17: Water quality in wetlands 2011 (see Figure 13 for sampling point names)

for water presence: f=flowing, s=stagnant); "u.d.l" = Under detection limit

Sampling point	Date	Water presence	DOC (mg-C/L)	NH ₄ (mg-NH ₄ /L)	NO ₂ (mg-NO ₂ /L)	NO ₃ (mg-NO ₃ /L)	PO ₄ (mg-PO ₄ /L)	TP (mg-P/L)	O ₂ (mg/L)	O ₂ (% sat.)	Temp (°C)	Conductivity (µS/cm)
H6	04.01.2011	f	2.5	u.d.l	u.d.l	65.8	0.07	u.d.l				
H6	17.01.2011	f	2.7	u.d.l	u.d.l	59.9	0.07	u.d.l				
H6	18.01.2011	f		u.d.l		60.8	0.1	0.25				
H6	19.01.2011	f		u.d.l		61.3	0.04	0.25				
H6	20.01.2011	f		u.d.l		61.6	0.06	0.25				
H6	21.01.2011	f		u.d.l		61.7	0.06	0.25				
H6	22.01.2011	f		u.d.l		62	0.11	0.25				
H6	31.01.2011	f	2.2	u.d.l	u.d.l	61.4	0.06	u.d.l	11		6.8	244.4
H6	04.02.2011	f		u.d.l		57.2	0.03	u.d.l				
H6	05.02.2011	f		u.d.l		56.8	u.d.l	u.d.l				
H6	06.02.2011	f		u.d.l		56.2	u.d.l	u.d.l				
H6	07.02.2011	f		u.d.l		56.6	0.2	0.1				
H6	08.02.2011			u.d.l		57	0.03	u.d.l				
H6	15.02.2011	f	2.2	u.d.l	u.d.l	53.7	0.11	u.d.l	9.4	82	7.8	255.9
H6	28.02.2011	f	2.2	u.d.l	u.d.l	45.7	0.05	u.d.l	8.4	70	7.5	255.3
H6	15.03.2011	f	1.9	u.d.l	u.d.l	45.9	u.d.l	u.d.l	10	87	8	269.7
H6	23.05.2012		3	u.d.l	u.d.l	23.3	0.08	0.1				
H6.2 Surface Lagune	15.03.2011								15.6	133	7.4	258.7
I6.1	15.02.2011	f	9.9	0.39	1	29.6	1.7	0.7	5.3	45	6.9	266.3
I6.2	04.01.2011	f	2.9	u.d.l	0.08	61.8	0.03	u.d.l				
I6.2	17.01.2011	f	2.8	0.18	0.1	56.4	0.03	u.d.l				
I6.2	31.01.2011	f	2.4	u.d.l	0.06	58.8	u.d.l	u.d.l				
I6.2	15.02.2011	f	2.8	u.d.l	0.12	48.1	u.d.l	u.d.l	12.1	102	6.4	243.3
I6.2	28.02.2011	f	2.9	u.d.l	0.18	38.7	0.04	u.d.l	8.6	73	8.3	255.8
I6.2	15.03.2011	f	2.9	u.d.l	0.18	38.6	u.d.l	u.d.l	14	120	7.4	260.3
J6	04.01.2011	f	2.7	u.d.l	u.d.l	65.7	0.11	u.d.l				
J6	17.01.2011	f	2.7	u.d.l	u.d.l	59.4	0.10	u.d.l				
J6	31.01.2011	f	2.3	u.d.l	u.d.l	60.9	0.09	u.d.l	8		6.1	243.3
J6	15.02.2011	f	3.6	u.d.l	0.03	51.6	0.57	0.2	5.1	44	7.5	265
J6	28.02.2011	f	3.0	u.d.l	u.d.l	31.5	0.16	u.d.l	13.2	109	7.3	248
J6	15.03.2011	f	2.3	u.d.l	0.03	42.8	0.09	u.d.l				

Table 18: Water quality in Infiltration ditch in 2013; = Under detection limit (DL) = DL/2

Date	Sampling point	DOC [mg-C/L]	NH ₄ [mg-NH ₄ /L]	NO ₂ [mg-NO ₂ /L]	NO ₃ [mg-NO ₃ /L]	PO ₄ [mg-PO ₄ /L]	TP [mg-P/L]	Sp. Cond [μS/cm]	Eh [mV]	O ₂ [mg/L]	O ₂ [% Sat]	Temp [°C]	pH
15.01.2013	A1	3.0	0.03	0.01	63.1	0.08	0.05	390	159	7.5	65	8.5	7.0
15.01.2013	B1	2.8	0.03	0.01	27.8	0.1	0.05	367	165	6.4	56	9.1	6.8
15.01.2013	C1.1							378	75	4.6	40	8.2	6.9
15.01.2013	D1	2.6	0.01	0.01	62.5	0.08	0.05	368	168	6.6	56	7.5	6.9
15.01.2013	E1	2.6	0.01	0.03	61.2	0.0125	0.05	362	167	6.8	58	7.9	6.9
23.01.2013	A1	2.8	0.03	0.08	59.8	0.16	0.05						
23.01.2013	B1	2.9	0.03	0.08	59.8	0.15	0.05						
23.01.2013	D1	3.0	0.01	0.07	60	0.15	0.05						
23.01.2013	E1	3.4	0.01	0.05	57.8	0.07	0.05						
29.01.2013	A1	3.2	0.09	0.21	57.6	0.19	0.12	367	246	8.4	75	9.0	7.0
29.01.2013	B1	3.3	0.08	0.21	57.6	0.18	0.12	358	241	7.9	70	9.0	6.8
29.01.2013	C1.1							359	225	7.5	66	9.0	6.9
29.01.2013	D1	3.3	0.04	0.18	58.4	0.17	0.12	362	230	7.4	66	9.0	6.9
29.01.2013	E1	3.4	0.01	0.1	58.3	0.09	0.05	372	227	8.3	74	9.3	7.0
05.02.2013	A1	3.0	0.12	0.27	50.9	0.21	0.18	341	183	8.7	73	7.1	7.1
05.02.2013	B1	3.2	0.06	0.22	50.4	0.17	0.18	330	186	14.3	121	7.5	7.0
05.02.2013	D1	3.2	0.03	0.15	51.4	0.16	0.14	347	180	8.2	69	7.3	6.9
11.02.2013	A1	4.0	0.2	0.2	46.7	0.3	0.1	361	183	7.7	67	7.8	7.1
11.02.2013	B1	4.0	0.2	0.2	46.9	0.3	0.1	356	165	7.8	67	7.4	6.9
11.02.2013	C1.1							348	165	8.0	69	7.3	
11.02.2013	D1	4.3	0.15	0.2	47	0.23	0.13	358	168	8.1	69	7.3	7.0
11.02.2013	E1	4.4	0.03	0.14	45.9	0.18	0.05	359	168	8.5	73	7.2	
20.02.2013	A1	1.8	0.01	0.02	60.1	0.13	0.05	352	230	10.7	90	7.3	7.3
20.02.2013	B1	1.9	0.01	0.03	60.2	0.13	0.05	353	247	10.5	88	7.2	6.7
20.02.2013	C1.1							353	245	10.6	90	7.5	6.8
20.02.2013	C1.2	2.1	0.01	0.01	59.5	0.09	0.29	362	75	8.5	70	6.6	6.7
20.02.2013	D1	1.8	0.01	0.02	59.8	0.13	0.05	356	247	11.3	95	7.1	6.9
20.02.2013	E1	2.5	0.01	0.05	54.4	0.07	0.05	375	245	12.5	107	8.1	7.1
26.02.2013	A1	3.2	0.24	0.14	53.1	0.24	0.11	456	195	10.6	86	6.4	6.9
26.02.2013	B1	3.1	0.21	0.14	53.3	0.22	0.1	357	223	10.6	87	6.5	6.5
26.02.2013	C1.1						0	358	233	9.6	79	6.6	6.4
26.02.2013	C1.2	2.7	0.08	0.12	53.6	0.09	0.34	359	157	9.5	77	6.4	6.7
26.02.2013	E1	2.7	0.01	0.07	52.4	0.07	0.05	361	180	9.6	79	6.6	6.6
11.03.2013	A1	7.1	0.39	0.07	12.3	0.59	0.77	170	166	11.4	94	5.4	7.4
11.03.2013	B1	6.3	0.4	0.07	12.5	0.59	0.8	160	159	11.3	93	5.4	6.8
11.03.2013	D1	7.3	0.44	0.06	13.3	0.49	0.6						
11.03.2013	E1	7.9	0.44	0.06	13.4	0.5	0.72						
08.04.2013	A1	2	0.01	0.05	54.2	0.23	0.11	359	202	10.9	97	8.9	6.9
08.04.2013	B1	2.1	0.01	0.06	53.9	0.23	0.05	359	201	10.9	97	9.0	6.9
08.04.2013	C1.2	2.2	0.01	0.01	53.1	0.24	0.32	361	202	9.3	83	9.0	7.0
08.04.2013	D1	2.1	0.01	0.02	53	0.14	0.86	358	203	9.9	87	8.7	7.0
08.04.2013	E1	2.6	0.01	0.01	50.8	0.06	0.4	363	188	12.3	110	9.0	7.2
17.04.2013	A1	2.1	0.04	0.04	52.2	0.21	0.05	347	171	10.4	95	10.4	7.4
17.04.2013	B1	2	0.01	0.04	52	0.2	0.05	347	176	10.0	90	10.3	6.8
17.04.2013	E1	3.2	0.49	0.05	48.6	0.15	0.05	349	117	9.6	88	10.9	7.7
22.04.2013	A1	2	0.01	0.03	52	0.1	0.05	353	174	10.5	94	10.1	7.2
22.04.2013	C-shaft							352	173	9.1	80	9.3	7.0
22.04.2013	B1	1.9	0.01	0.04	51.5	0.11	0.05	353	183	10.4	93	10.0	6.9
22.04.2013	C1.1							353	182	7.9	70	9.9	7.0
22.04.2013	C1.2	1.9	0.12	0.01	50.7	0.07	0.28	351	159	7.7	69	9.9	7.0

22.04.2013	E1	2.3	0.01	0.02	47.1	0.07	0.05	347	193	10.4	93	10.0	7.7
02.05.2013	A1	1.5	0.01	0.04	53.6	0.09	0.05	348	173	11.0	98	10.1	8.1
02.05.2013	C-shaft							348	168	9.0	79	9.2	7.8
02.05.2013	B1	1.6	0.05	0.05	53.5	0.14	0.05	349	163	9.4	84	10.0	7.4
02.05.2013	C1.1							352	164	8.3	74	9.9	7.5
02.05.2013	C1.2	1.7	0.01	0.01	51.6	0.11	0.28	352	160	7.2	64	10.0	7.4
02.05.2013	E1	2.1	0.01	0.04	47.7	0.07	0.11	348	168	9.2	83	10.3	7.4
06.05.2013	A1	1.8	0.01	0.06	52.8	0.09	0.05	347	150	10.2	97	12.6	7.0
06.05.2013	C-shaft							349	149	7.7	68	9.4	7.0
06.05.2013	B1	1.7	0.02	0.05	52.6	0.09	0.05	348	148	9.3	86	11.4	7.1
06.05.2013	C1.1							347	146	7.8	71	11.0	7.1
06.05.2013	C1.2	1.8	0.03	0.01	49.8	0.07	0.21	349	126	6.8	64	11.2	7.1
06.05.2013	E1	2.6	0.03	0.14	44.4	0.08	0.05	350	164	7.8	74	12.4	7.4
14.05.2013	A1	2	0.07	0.1	54.2	0.13	0.11	379	142	9.0	82	10.5	7.5
14.05.2013	C-shaft							344	177	7.0	63	9.8	7.2
14.05.2013	B1	1.6	0.03	0.1	53.1	0.13	0.05	345	193	8.8	80	9.9	7.0
14.05.2013	C1.1							344	196	7.1	64	9.9	7.0
14.05.2013	C1.2	2	0.01	0.01	49.2	0.17	0.14	346	177	5.9	54	10.4	7.0
14.05.2013	E1	3.2	0.06	0.14	39.9	0.1	0.05	355	177	6.4	58	10.5	7.1
21.05.2013	A1	1.9	0.07	0.21	50.6	0.19	0.05	345	189	6.4	59	11.0	7.2
21.05.2013	C-shaft							335	163	0.7	7	9.9	7.0
21.05.2013	B1	1.8	0.07	0.19	50.4	0.18	0.05	342	190	7.7	71	10.7	7.4
21.05.2013	C1.1							343	188	5.1	46	10.7	7.4
21.05.2013	C1.2	2.3	0.01	0.03	48.5	0.18	0.15	346	166	5.2	48	11.0	7.1
21.05.2013	E1	3.5	0.13	0.33	34.6	0.1	0.05	345	167	5.8	53	11.2	7.2
27.05.2013	A1	2	0.06	0.21	50.9	0.21	0.1	372	259	8.2	74	9.7	7.9
27.05.2013	C-shaft							345	239	5.6	48	8.3	7.1
27.05.2013	B1	2	0.1	0.22	43.1	0.16	0.05	343	235	7.2	64	8.8	7.2
27.05.2013	C1.1							343	240	3.6	32	8.8	7.1
27.05.2013	C1.2	2.5	0.04	0.04	42.6	0.18	0.17	353	237	4.2	39	11.0	7.5
27.05.2013	E1	3.8	0.24	0.38	19.7	0.1	0.05	346	238	6.3	58	10.1	7.4
30.05.2013	C-shaft							340	210	3.5	31	9.7	7.2
30.05.2013	B1	3	0.07	0.28	43.8	0.25	0.05	342	209	7.5	67	10.3	7.3
30.05.2013	C1.1							344	208	5.3	48	10.1	7.2
30.05.2013	C1.2	3.9	0.05	0.03	39.8	0.15	0.21	357	205	2.5	23	10.7	7.2
30.05.2013	E1	4.2	0.24	0.7	20.8	0.13	0.05	347	225	4.8	44	11.3	7.3

Table 19: Water quality in Wetlands in 2012/13; = Under detection limit (DL) = DL/2 (see Figure 14 for sampling point names)

Date	Sampling point	DOC [mg-C/L]	NH ₄ [mg-NH ₄ /L]	NO ₂ [mg-NO ₂ /L]	NO ₃ [mg-NO ₃ /L]	PO ₄ [mg-PO ₄ /L]	TP [mg-P/L]	Sp. Cond [μS/cm]	Eh [mV]	O ₂ [mg/L]	O ₂ [% Sat]	Temp [°C]	pH
04.12.2012	H6	3.4	0.01	0.01	85.1	0.14	0.05						
04.12.2012	J6	4.1	0.01	0.13	81.2	0.6	0.21						
04.12.2012	I6.2	3.4	0.06	0.24	81.7	0.09	0.05						
18.12.2012	H6	3.5	0.01	0.01	85.1	0.1	0.05	471	201	9.8	86	9.3	7.1
18.12.2012	J6	3.5	0.01	0.01	84.5	0.19	0.05	464	192	8.2	76	8.4	6.9
18.12.2012	I6.2	3.7	0.04	0.08	81	0.08	0.05	457	197	5.9	50	7.7	6.9
15.01.2013	H6	3	0.01	0.01	66.2	0.08	0.05	425	116	8.6	75	8.3	7.0
15.01.2013	J6	3.1	0.01	0.01	63.5	0.17	0.05	425	123	5.9	51	8.2	7.0
15.01.2013	I6.2	3.4	0.04	0.04	63.7	0.05	0.05	411	242	11.2	98	8.7	6.9
23.01.2013	H6	3	0.01	0.01	62.6	0.09	0.05						
23.01.2013	J6	3.2	0.01	0.01	61.2	0.18	0.05						
23.01.2013	I6.2	3.2	0.02	0.04	59.6	0.07	0.05						
29.01.2013	H6	3.3	0.01	0.01	63.7	0.09	0.05	411	240	12.3	108	8.8	7.1
29.01.2013	J6	3.3	0.01	0.01	63.9	0.2	0.05	414	241	8.5	73	8.4	6.9
29.01.2013	I6.2	3.3	0.01	0.01	64.3	0.08	0.05	411	242	11.2	98	8.7	7.0
05.02.2013	H6	3.1	0.05	0.02	61.2	0.06	0.05	393	80	10.3	88	7.7	7.1
05.02.2013	J6	3.2	0.01	0.01	63.9	0.18	0.05	422	146	6.3	54	8.0	6.9
05.02.2013	I6.2	3.3	0.03	0.05	63.6	0.11	0.26	387	170	6.7	56	6.7	7.0
11.02.2013	H6	3.3	0.01	0.01	60.1	0.09	0.05	399	173	8.4	72	7.6	7.0
11.02.2013	J6	3.4	0.01	0.01	58.3	0.17	0.05	396	174	6.1	52	7.0	6.9
11.02.2013	I6.2	3.5	0.02	0.02	57.5	0.08	0.05	393	175	8.1	68	6.7	7.0
20.02.2013	H6	2.7	0.01	0.01	63.3	0.04	0.05	398	249	11.7	98	6.7	7.1
20.02.2013	J6	2.8	0.01	0.01	62.6	0.11	0.05	400	246	8.6	71	6.3	7.1
20.02.2013	I6.2	2.9	0.01	0.05	61	0.05	0.05	398	247	10.1	80	5.0	7.2
26.02.2013	H6	2.7	0.01	0.01	55.8	0.07	0.05	379	182	12.2	99	6.5	7.3
26.02.2013	J6	2.7	0.01	0.01	55.6	0.12	0.05	395	183	7.7	62	5.9	7.2
26.02.2013	I6.2	2.6	0.01	0.03	57.7	0.07	0.05	392	184	10.6	85	5.6	7.1
11.03.2013	H6	4.9	0.26	0.06	37.2	0.53	0.53	270	162	11.6	97	6.4	7.1
11.03.2013	J6	5.3	0.06	0.05	37.2	0.33	0.26	270	163	10.1	85	6.5	7.1
11.03.2013	I6.2	5	0.24	0.07	37.3	0.56	0.44	270	163	10.9	91	6.1	7.0
08.04.2013	H6	2.5	0.01	0.01	50	0.03	0.16	376	202	11.4	99	8.1	7.4
08.04.2013	J6	2.6	0.01	0.01	47.1	0.07	0.05	380	205	6.7	57	6.7	7.3
08.04.2013	I6.2	2.7	0.01	0.04	47.8	0.09	0.05	374	206	9.6	82	7.2	7.3
17.04.2013	H6	2.5	0.04	0.01	46.2	0.06	0.05	373	186	11.4	101	9.3	7.4
17.04.2013	J6	2.6	0.01	0.02	42.9	0.08	0.05	376	189	4.7	41	9.3	7.2
17.04.2013	I6.2	2.8	0.02	0.07	41.3	0.0125	0.05	366	187	6.8	61	9.8	7.1
22.04.2013	H6	2.4	0.01	0.01	46.6	0.05	0.05	379	192	11.6	102	9.3	7.6
22.04.2013	J6	2.4	0.01	0.01	44.1	0.07	0.05	382	194	5.2	44	8.4	7.3
22.04.2013	I6.2	2.6	0.01	0.07	41.6	0.0125	0.05	375	195	8.4	72	8.1	7.2
02.05.2013	H6	2.2	0.01	0.01	41.8	0.05	0.05	375	173	10.2	90	9.4	7.7
02.05.2013	J6	2.4	0.01	0.03	36.4	0.08	0.05	384	174	3.6	32	9.2	7.5
02.05.2013	I6.2	2.6	0.01	0.13	31.5	0.0125	0.05	368	175	6.2	53	8.5	7.2
06.05.2013	H6	2.2	0.01	0.01	40.7	0.05	0.05	373	116	10.8	97	10.6	7.6
06.05.2013	J6	2.5	0.01	0.06	32.1	0.08	0.05	384	149	2.3	21	9.6	7.1
06.05.2013	I6.2	2.8	0.01	0.16	29.8	0.0125	0.05	364	154	6.5	58	9.7	7.0

14.05.2013	H6	2.3	0.02	0.02	38.3	0.05	0.05	379	192	8.4	77	10.4	7.5
14.05.2013	I6.2	3.1	0.01	0.24	25.2	0.0125	0.05	366	193	4.8	44	10.2	6.9
21.05.2013	H6	2.3	0.01	0.03	41.1	0.05	0.05	452	177	9.7	89	11.0	7.6
21.05.2013	I6.2	3.3	0.04	0.28	26	0.0125	0.05	371	179	4.1	37	10.5	6.9
27.05.2013	H6	2.2	0.01	0.01	40.9	0.03	0.05	403	236	9.8	87	9.5	7.7
27.05.2013	I6.2	3.6	0.01	0.3	15.3	0.0125	0.05	361	237	5.1	45	9.1	7.0
30.05.2013	H6	2.5	0.01	0.01	38.5	0.05	0.05	383	226	9.0	84	11.0	8.0
30.05.2013	I6.2	3.7	0.01	0.28	20.7	0.0125	0.05	352	217	4.4	40	10.2	7.2
04.06.2013	H6	2.4	0.02	0.01	33.8	0.05	0.05						
04.06.2013	I6.2	4.7	0.04	0.44	6.7	0.0125	0.05						

Bibliography

- Baker L.A. (1998) Design consideration and application for wetland treatment of high-nitrate waters. *Water Science and Technology* 38(1): 389-395
- Chapman, T. G., and A. I. Maxwell. 1996. Baseflow separation—Comparison of numerical methods with tracer experiments, paper presented at Hydrology and Water Resources Symposium, Inst. of Eng. Aust., Hobart, Tasmania, 1996.
- Eckhardt K, 2005. How to construct recursive digital filters for baseflow separation, *Hydrological Processes* 19, 507-515.
- Kadlec, R. H., and S. D. Wallace. 2009. Treatment Wetlands, 2 ed. CRC Press.
- Lyne, V., and M. Hollick. 1979, Stochastic time-variable rainfall-runoff modelling, I.E. Aust. Natl. Conf. Publ. 79/10, pp. 89–93, Inst. of Eng. Aust., Canberra, ACT, 1979.
- Lim K.J., Engel B.A., Tang Z., Choi J., Kim K., Muthukrishnan S., and Tripathy D. 2005. Web GIS-based Hydrograph Analysis Tool, WHAT. *JAWRA*, 41(6): 1407-1416.
- Périllon C. and Matzinger A, 2010. Identification of existing mitigation systems that can attenuate nitrates during high flow events from drained, agricultural fields. Report Aquisafe 2 D1.1, KompetenzZentrum Wasser Berlin, 48 S.
- SEEGT, SMEGA, KWB, 2011. Réaménagement d'une zone tampon de type "Fossé réactif" _ Cahier des Prescriptions techniques. *Document interne*
- U.S.EPA (1993) Design manual: Nitrogen control, EPA 625/R-93/010, U.S.EPA Office of Research and Development: Washington D.C.