



CWPharma2

CLEAR WATERS FROM PHARMACEUTICALS

WWTP fitness check for API removal technology – summary report

GoA2.1: Fitness check for API removal technology

December 2021



EUROPEAN REGIONAL DEVELOPMENT FUND

Authors/Contributors:

Stapf, Michael (Kompetenzzentrum Wasser Berlin, KWB)

Zhiteneva, Veronika (KWB)

Saoudi, Rami (KWB)

Miehe, Ulf (KWB)

Kharel, Suman (Aarhus University, AU)

Bester, Kai (AU)

Kuokkanen, Anna (Helsinki Region Environmental Services Authority, HSY)

Bogusz, Aleksandra (Institute of Environmental Protection, IOS)

Trzcińska, Magdalena (IOS)

Lember, Erki (Estonian Water Works Association, EVEL)

Muulmann, Mihkel (EVEL)

Putna-Nīmane, Ieva (Latvian Institute of Aquatic Ecology, LIAE)

Liepina-Leimane, Ineta (LIAE)

Thisgaard, Preben (Kalundborg Utility, Kalfor)

Melchiorson, Line Rodenkam (Kalfor)

Brauner, Tobias Buck (Kalfor)

Funding

This report was funded by the European Union, Interreg Baltic Sea Region, European Regional Development Fund.

Table of content

Introduction.....	5
Technologies for API reduction	5
Methodology.....	9
Questionnaires.....	9
Overview of surveyed WWTPs.....	9
Sampling and laboratory protocol and analysis	9
Results	11
Evaluation of the questionnaire	11
Specific wastewater flow	11
Share of industrial wastewater	11
Sludge disposal.....	12
Current WWTP status and future plans	13
Data availability for specific water quality parameters	14
APIs: Experiences and motivation.....	15
Analysis of water samples received	17
Chemical oxygen demand (COD)	17
Dissolved organic carbon (DOC)	18
Ultraviolet absorption at 254 nm (UVA ₂₅₄)	19
Nitrite	19
Bromide	20
Conductivity.....	21
APIs.....	22
Evaluation for the individual fitness-check.....	24
Data availability	24
Expected dosages of ozone or PAC	24
Barriers	24
Interaction with other treatment goals	24
Use of existing infrastructure	25
Summary	26
References	27
Appendix.....	I
Appendix A: Questionnaire that was sent out to the WWTPs (English version)	II
Appendix B: Data availability of water quality parameters.....	V

Appendix C: API concentrations by substance.....	VI
Appendix D: API concentrations by country.....	IX
Appendix E: Risk quotients by country	XIII
Appendix F: API overview	XVII
Appendix G: Directions for reading the boxplots.....	XVIII

Introduction

This report covers the results of the Clear Waters from Pharmaceuticals 2 (CWPharma 2¹) project continuing the work of the original CWPharma² project which concluded in December 2020. Both projects were funded by the EU's Interreg Baltic Sea Region Programme. CWPharma evaluated occurrence and routes of active pharmaceutical ingredients (APIs) in the water cycle and provided recommendations on technical and non-technical measures to reduce API loads entering the Baltic Sea. Recommendations for technical measures were published in the CWPharma 'Guidelines for advanced API removal processes' (Stapf et al., 2020), which also includes a modular approach to their successful implementation. The individual modules are: 1) WWTP fitness check, 2) feasibility study, 3) detailed planning, and 4) optimization of existing systems.

Within CWPharma 2, project partners from Denmark, Estonia, Finland, Germany, Latvia, and Poland continued the work of reducing API loads from the aforementioned countries into the Baltic Sea. The focus was to help wastewater treatment plant (WWTP) operators interested in reducing their API discharges to practically implement the four different modules of the guideline. This report summarizes the results of the first module 'WWTP fitness check' that have been carried out for about 80 WWTPs from eight Baltic Sea countries and aggregates the anonymized data from the WWTPs to present an overview of general as well as country-specific results, trends and considerations.

Technologies for API reduction

Besides biodegradation or adsorption to sludge, APIs are eliminated at WWTPs with technologies that either destroy their chemical structure (e.g. ozonation or other advanced oxidation processes) or remove them physically from the water (e.g. activated carbon or membranes). In practice and at full-scale, ozonation and activated carbon in powdered (PAC) or granular (GAC) form are mainly used at municipal WWTPs and are described briefly within this report. More details can be found in the CWPharma guideline (Stapf et al., 2020).

Ozonation

Ozone is a strong oxidant that has to be produced on-site. When ozone is introduced into water it reacts with several compounds in water, including APIs. The application of ozone, which is a selective oxidant, in water also results in the formation of hydroxyl-radicals ($\bullet\text{OH}$), which are an even more powerful oxidant. These radicals are non-selective oxidants and are therefore able to attack substances which cannot be attacked by ozone due to their chemical structure. Ozone doses typically applied for API elimination transform the molecular structure of the organic compounds but do not necessarily result in their mineralization.

The resulting transformation and oxidation by-products³ formed during ozonation are often associated with ecotoxicological effects (e.g. mutagenic effects). However, many by-products are more biodegradable than the parent substance and can be removed by subsequent biological post-treatment, which is mandatory after ozonation. Depending on the method for producing electricity in a country, however, ozonation can be energy- and cost-intensive.

Relevant water quality parameters for the ozonation process are dissolved organic carbon (DOC), nitrite and bromide concentrations. DOC determines the level of the required ozone dose, as typical ozonation plants are designed for specific ozone doses between 0.3 and 0.7 mg $\text{O}_3/\text{mg DOC}$. Ozone demand also increases if highly reactive nitrite is present in the water, as 3.43 mg $\text{O}_3/\text{mg N}$ are consumed in the rapid transformation of nitrite into nitrate. Bromide is a

¹ <https://projects.au.dk/waterpurification/cwpharma-2/>

² <https://www.cwpharma.fi/en-US>

³ Transformation products (TPs) describe substances originating from the target substances of the treatment process (for this report, APIs), whereas oxidation by-products (OBP) describe substances originating from other (non API) substances (e.g. bromide, nitrite ...).

precursor of bromate, a carcinogenic oxidation by-product. At bromide concentrations up to 150 µg/L and applied ozone doses up to 0.7 mg O₃/mg DOC, bromate formation in full-scale plants is not expected to be critical. At higher bromide concentrations, bromate formation in the local water matrix should be checked in ozonation lab-scale experiments. A scheme of an exemplary ozonation plan is shown in Figure 1.

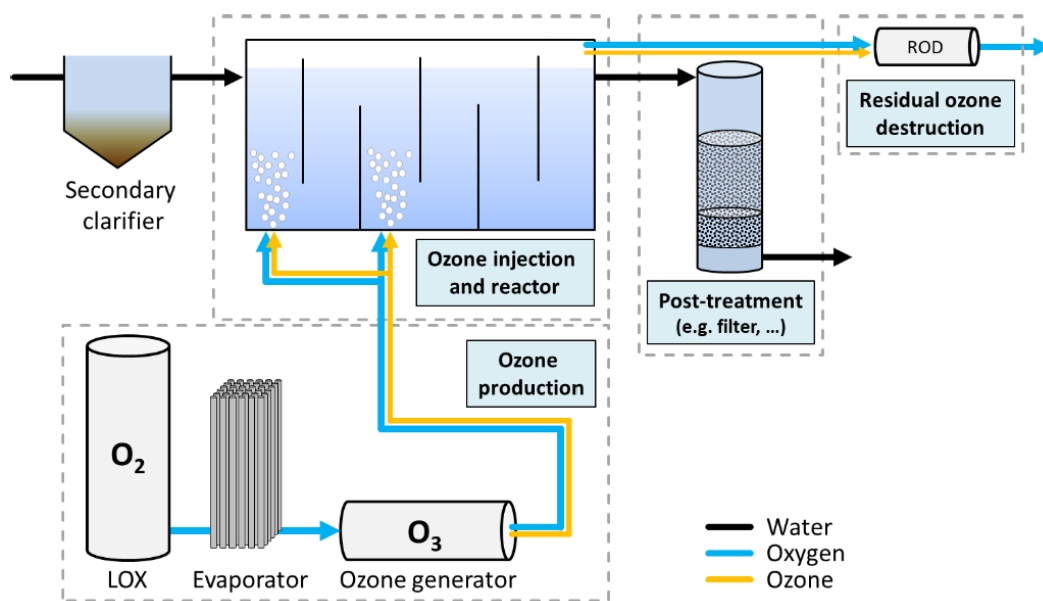

Figure 1: Scheme of a full-scale ozonation plant consisting of an ozone production unit, an ozone injection and reactor, an off-gas treatment, and post-treatment. Source: Stapf et al. (2020).

Activated carbon processes

Activated carbon (AC) has been used for decades to remove xenobiotics such as pesticides or chlorinated solvents in drinking water production. It can also be used to remove APIs at WWTPs through compound interactions with the hydrophobic AC surface, known as adsorption. Activated carbon is commercially available as a granulated (GAC) or powdered (PAC) product, which differ in the size of the AC grains. A typical range for the diameter of a GAC grain is 0.5 – 2.5 mm, whereas PAC grains are much smaller (0.005 – 0.1 mm). Activated carbon is generated from carbon-containing raw material (e.g. coal, lignite, wood, etc.) by chemical or thermal activation and has a high carbon footprint.

The overall API removal by activated carbon depends on 1) the concentrations and chemical characteristics of the APIs; 2) the dosage and the characteristics of the activated carbon used; 3) the contact time between water and activated carbon; and to a lesser extent, 4) the water temperature and pH value. Non-polar, hydrophobic, and small molecules (e.g. carbamazepine, benzotriazole) are usually well adsorbed, in contrast to polar molecules (e.g. gabapentin, sulfamethoxazole). Substances with a high molecular mass, such as x-ray contrast media, are also poorly adsorbed.

Although PAC and GAC are made of the same material their practical application differs. PAC is mixed directly into the wastewater stream and requires filtration after application to remove PAC prior to discharging the wastewater effluent to receiving water. GAC, on the other hand, is used directly as a filter material but eventually loses its adsorptive ability as more APIs are adsorbed onto its surface over time. Exhausted GAC must eventually be replaced by new GAC once the desired API removal can no longer be achieved, and the exhausted GAC is either regenerated for further use, or incinerated and disposed of. PAC is always incinerated. To utilize the full adsorption capacity of a PAC process, it is usually recirculated into the main biological treatment, where PAC particles are incorporated into the activated sludge and are removed with the excess sludge. Therefore, excess sludge cannot be disposed on agricultural fields and must be incinerated. In principle, it would be possible to use a separate PAC sludge cycle which would undergo different treatment than the excess sludge. However, this has not yet been applied at full-scale.

The most important water quality parameter for activated carbon processes is DOC, since other organic compounds compete with the APIs for the activated carbon adsorption sites. The PAC dosage can therefore be normalized to the DOC concentration (typical range is 1 – 2 mg PAC/mg DOC). Likewise, GAC must be more frequently replaced in the presence of elevated DOC concentrations. Whether a PAC or GAC process is more appropriate for a specific WWTP depends on several local specific aspects, such as existing/unused infrastructure, sludge disposal routes, water matrix, and API elimination target. Schemes of PAC and GAC processes are depicted in Figure 2 and Figure 3.

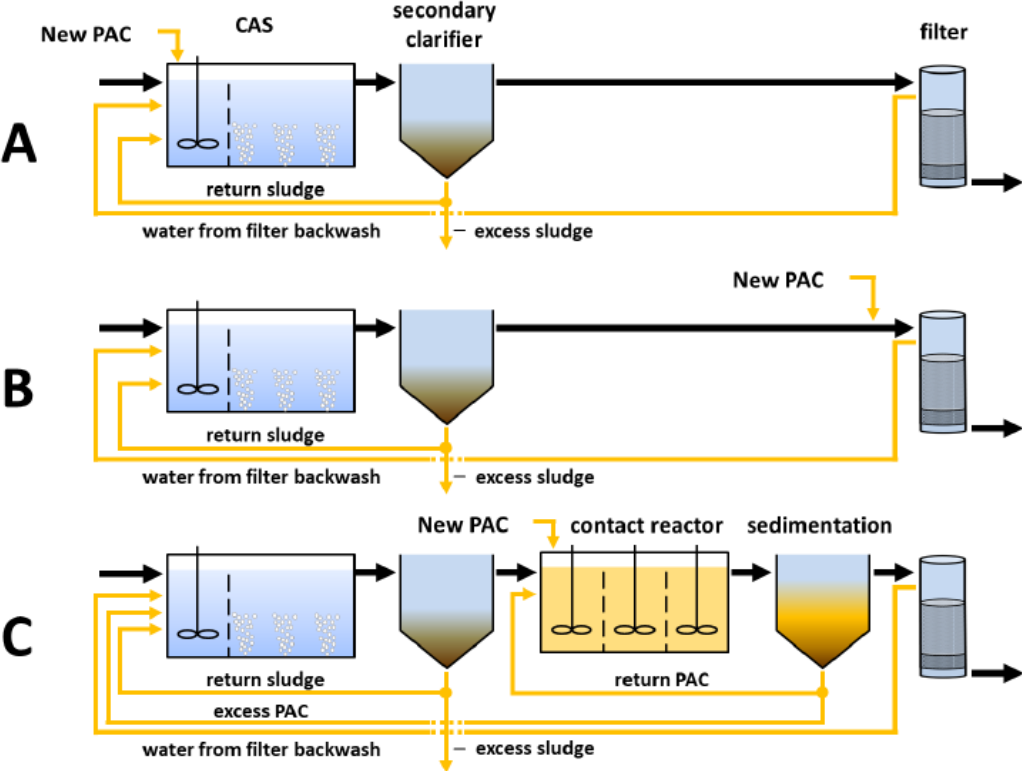

Figure 2: Schematic overview of different PAC processes which have been applied at full-scale plants: A) simultaneous PAC dosage, B) PAC dosage prior to a filter, and C) separate PAC contact reactor (“Ulmer process”). Source: Stapf et al. (2020).

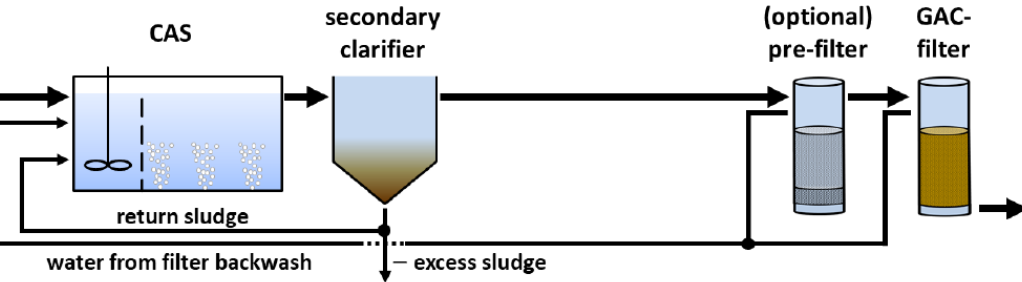

Figure 3: Scheme of a full-scale GAC process. Source: Stapf et al. (2020).

Scope of the WWTP fitness check

Before conducting a feasibility study or beginning detailed planning of an API elimination technology, the current WWTP processes should be evaluated in order to 1) define the overall targets of API elimination process, 2) identify possible data gaps which would require specific monitoring campaigns, and 3) identify potential barriers that could impede the implementation of certain technologies.

Define the overall target of the future API elimination technology

Unless targets are defined by the appropriate authority, the focus of the API elimination might be reduction of overall API emission from WWTPs, surface water protection, or securing water sources used for drinking water, among other reasons. Also, potential synergies with other WWTP goals (e.g. reduction of phosphorous and/or COD emissions or heavy metals (AC), disinfection (ozone), etc.) should be checked.

Measurement of relevant water quality parameters

Relevant parameters for determining the correct API elimination technology include DOC, nitrite, bromide, and total suspended solids (TSS) at the influent of the potential process, which in most cases is the WWTP secondary effluent. However, some of the aforementioned parameters are not regularly measured at WWTPs.

Identify potential barriers to implementation

Local water quality and boundary conditions can favor or prevent the application of certain technologies. Potential handicaps include 1) the desired application of excess sludge disposal in agriculture (with PAC it would have to be incinerated); 2) elevated bromide concentrations ($> 150 \mu\text{g/L}$) can pose a risk of increased bromate formation at an ozonation; and 3) elevated nitrite concentrations can increase the ozone demand. Elevated DOC concentrations will require higher doses of AC and ozone. If the WWTP has a high share of industrial wastewater (e.g. distinctly higher DOC), conclusions from other WWTPs with API elimination process might not be transferable and lab testing with the local water matrix would be required. Additionally, insufficiently working clarifiers and elevated TSS concentration might also affect API elimination stages (e.g. more frequent flushing of GAC filters, increased dosage, etc.).

It is important to keep in mind that identified barriers do not automatically result in excluding one or the other treatment processes, but could be a starting point for more detailed investigations on how to overcome them, if required.

Fitness check results

The outcome of such a WWTP fitness check should be a short report which highlights the current situation, the advantages and disadvantages of the API elimination technologies, and provides recommendations for further actions required to enable the WWTP to more effectively eliminate APIs.

Methodology

The individual WWPT fitness checks included a questionnaire and the analysis of a single wastewater sample taken from the secondary or WWTP effluent. These two elements provided a rough idea of water quality parameter concentrations. It should be noted that data shown for the different countries only represent the WWTPs evaluated within the CWPharma 2 project. Therefore, results are intended to provide initial reference values and are not wholly representative of each country.

Questionnaires

The questionnaire consisted of 19 questions and focused on acquiring information about the general WWTP treatment processes, water quality parameters measured at the WWTPs, and the WWTP attitude towards API removal. The 19 questions were agreed upon by CWPharma 2 partners, and were partially translated into the national language (DE, LT, LV and PL) prior to distribution to the WWTP operators. The original English version of the questionnaire can be found in **Appendix A**. The countries which received the questionnaires were Germany (DE), Denmark (DK), Estonia (EE), Finland (FI), Lithuania (LT), Latvia (LV), Poland (PL), and Sweden (SE).

Overview of surveyed WWTPs

The WWTP operators were contacted either through personal contacts of CWPharma 2 project partners (e.g. EE, DK, SE), through water/wastewater associations (DE, LT, LV)⁴, and/or were pre-selected using the UWWTD database and contacted through the according national project partner (FI, PL). All WWTPs which responded to the questionnaire were assigned a country and number code (e.g. DK_01, DK_02 ...) to ensure anonymity during evaluation. Data from the questionnaires was anonymized and pooled per country or per question. Data analysis was then conducted using R and R Studio (R Core Team, 2021), and fitness-checks for the individual WWTPs were created via a script using R Markdown⁵.

As WWTP size often influences the WWTP treatment processes employed (C, N, P removal), the population equivalents (PE) of the WWTPs are summarized in Table 1.

Table 1: Population equivalents (PE) of WWTPs which responded to the questionnaire and sent samples for analysis. *One SE WWTP sent two samples from different treatment trains of the same WWTP.

Country	WWTPs	Samples	< 10k PE	10 - 50k PE	50 - 100k PE	100 - 250k PE	> 250 k PE
DE	5	5	0	0	2	1	2
DK	34	34	2	13	7	8	4
EE	6	6	0	3	1	1	1
FI	12	11	0	0	1	8	3
LT	2	2	0	1	0	0	1
LV	6	6	1	4	0	0	1
PL	10	10	1	0	1	0	8
SE	8	8*	0	0	0	6	2
Total	83	82	4	21	12	24	22

Sampling and laboratory protocol and analysis

To participate in the sampling campaign, WWTPs operators had to collect a sample of secondary WWTP effluent (500 mL), preferably over 24 hours and during dry weather. All samples were taken in summer (June - July). The samples were then immediately shipped to KWB in a Styrofoam box with ice packs. Wherever this was not possible (e.g. operators sampled from

⁴ Special thanks to the German Association for Water, Wastewater and Waste (DWA)

⁵ <https://rmarkdown.rstudio.com/>

tertiary WWTP effluent, and so forth (~30% of samples)) operators informed the team and this information was carried through the subsequent analysis.

Samples were processed the same day they arrived at KWB. Each sample was divided into 1) a ~30 mL sample which was frozen prior to shipment to Aarhus University for API analysis; 2) a 200 mL sample which was frozen prior to transport to the Technical University of Berlin for bromide and DOC analysis; and 3) a 150 mL sample which was frozen and stored as backup at KWB. The remaining 120 mL of sample were used for on-site analyses. Temperature, pH and conductivity were measured with a handheld multiparameter instrument (YSI Professional Plus Aqualyse and/or WTW Multi 3420). Approximately 30 mL of sample were filtered through a 0.45 µm syringe filter (PET, CHROMAFIL®) for analysis of nitrite, dissolved COD, and ultraviolet absorption (UVA). Hach test kits were used for nitrite and COD (LCK314 for COD, LCK341 for nitrite). Absorption at 254 nm was analyzed on a spectrophotometer (Hach DR6000). The remainder of the sample was homogenized (IKA T10 basic) prior to analyzing total COD (Hach LCK314).

DOC was analyzed using thermic-catalytic oxidation and measurement of the produced CO₂ via NDIR according to DIN EN 1484 (varioTOC Cube, Elementar Analysensysteme). Bromide was measured by HPLC ion chromatography (Dionex IonPac AS/AG 23-4µm) and a UV detector (210 nm) according to DIN EN ISO 10304-1.

For API analysis at Aarhus University, samples were centrifuged at 5000 rpm for 10 minutes. 900 µL supernatant of samples were taken in an HPLC vial and 100 µL internal standard is added (final volume 1 mL). Samples were analyzed via direct injection using HPLC-MS/MS. The separations were conducted using a Synergi polar-RP column (150*2 mm I.D., particle size 4 µm, Phenomenex, Torrance, California, USA). The chromatographic separations were achieved using a multi-step gradient with acidic elution (0.2% formic acid) of water (A) and methanol (B) at a flow of 250-350 µL/min. 100 µL samples were injected. The separations were conducted using an Ultimate 3000 dual gradient low pressure mixing HPLC-system (Dionex, Sunnyvale, CA, USA) coupled to an API 4000 triple-quadrupole-MS mass spectrometer (AB Sciex, Framingham, MA, USA), utilizing electrospray ionization (ESI (+)) and detection in MRM (multiple reaction monitoring) modus.

Results

The results of the questionnaires are separated into two sections: information which was provided by the WWTPs and analyzed water quality parameters of the wastewater samples. When answering the questionnaire, WWTPs could provide values for their secondary effluent, their WWTP effluent, or both. All results were plotted and are discussed in this chapter.

Evaluation of the questionnaire

Specific wastewater flow

The WWTPs surveyed reported a range of PE as well as annual treatment capacities. Of the WWTPs which responded to the questionnaire, the greatest average annual treatment normalized to PE was found in DK, EE, FI and SE (Figure 4). The highest share of wastewater per PE in the CWPharma 2 countries was in SE, whereas the lowest was in PL, DE, LT and LV (although DE and LT returned only a few questionnaires ($n \leq 5$ each)). The general trend of higher specific wastewater flow in the “northern” countries compared to the others was also reported by the IWAMA project (Rettig et al., 2018). These differences in the specific wastewater flow should be kept in mind when using cost estimates or assumptions from different countries.

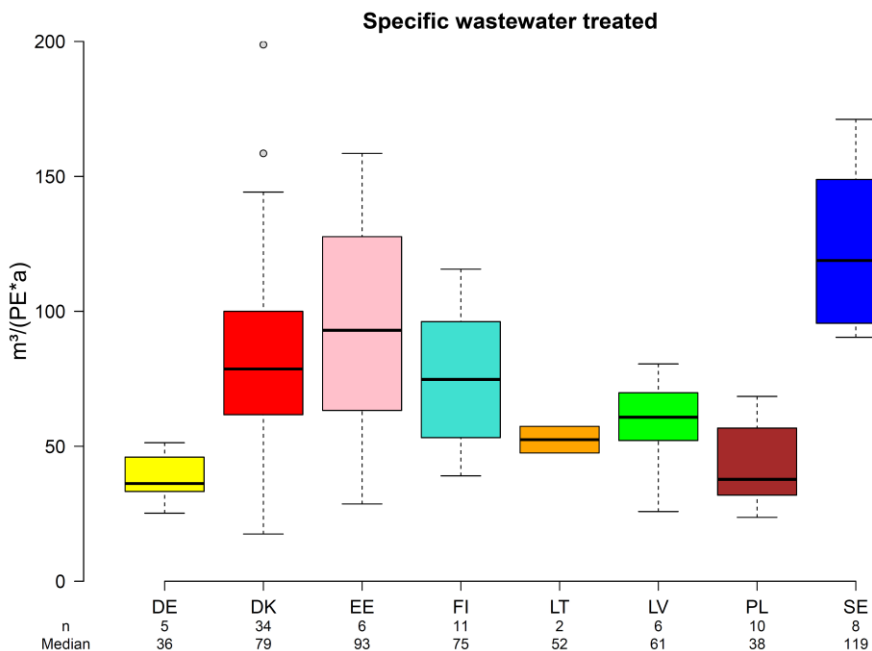

Figure 4: Wastewater treated in cubic meters per P.E. per year in the participating WWTPs.

Share of industrial wastewater

WWTP operators were also asked to estimate the share of industrial wastewater coming into their WWTP. High influence of industrial wastewater was denoted as > 30% of the overall wastewater treated, calculated either via flow or loading, medium as 10-30%, and low as < 10% (see also questionnaire in **Appendix A**). Overall, 10-20% of WWTPs in each country reported high industrial wastewater influence, with > 20% of WWTPs in DK and LT ($n = 1$) reporting high shares (Figure 5). The shares were reported mainly based on load, which is important, as a high share of industrial wastewater may result in higher DOC concentrations.

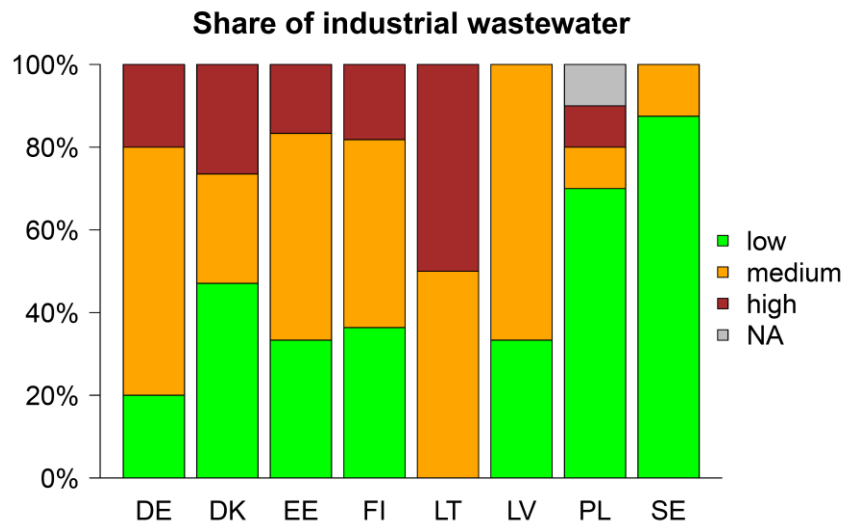

Figure 5: Shares of industrial wastewater in the WWTPs.

Sludge disposal

Treatment and disposal of excess sludge is of particular importance for PAC processes, since PAC is usually recycled back into the main biological treatment stage where it is incorporated into the sludge flocks. Thus, the fate of the loaded PAC is linked to the handling of the excess sludge. Based on the feedback from the WWTPs, most frequent answer was that the excess sludge eventually ends up in agriculture (~ 70%), while landscaping and incineration were mentioned by 20% each (Figure 6). The category 'other' included cement production, disposal by external companies/WWTPs or that the WWTP does not use activated sludge. Some answers specified that sludge was composted before it was used in agriculture. Consequently, if composting was mentioned as 'others' it was only treated as disposal in agriculture. Sludge disposal varied not only between the BSR countries but also between WWTPs in the same country, which also sometimes use several disposal options. Sludge disposal in agriculture is common in all countries, whereas usage for landscaping is more common in SE, EE, and FI as well as by one WWTP in LV. In contrast, incineration is used in all countries except EE, FI, and LV.

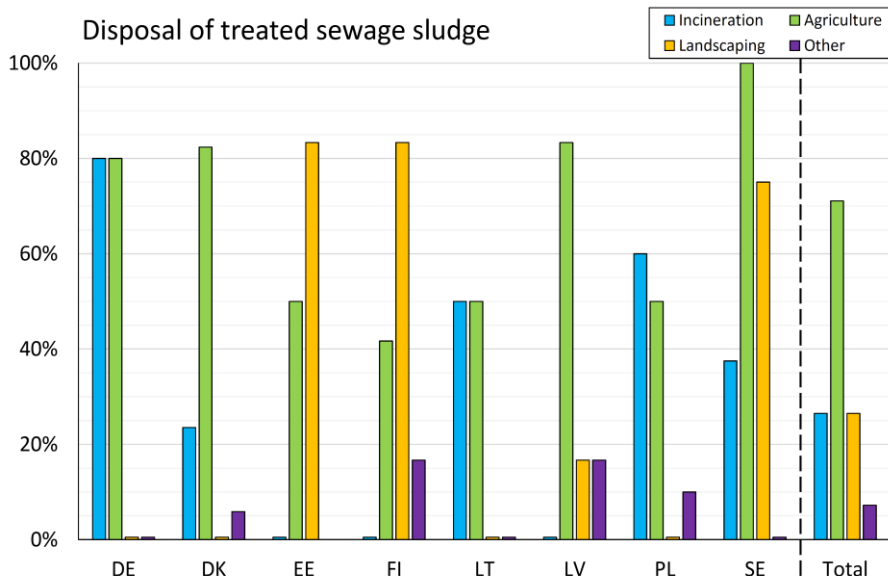

Figure 6: Methods of sewage disposal per country (multiple choice answer possible).

Current WWTP status and future plans

Based on the questionnaire feedback, the summary of the current treatment processes of the participating WWTPs were:

- **Primary treatment:**
Except for some WWTPs in DK and LV, most participating WWTPs use screening and sand / grit removal (overall: 85% and 94%). Even though the majority (69%) of the WWTPs use sedimentation or clarifiers at the primary treatment stage, differences between the countries were observed: in FI and SE, all WWTPs are equipped with sedimentation/clarifiers, whereas this was the case for only half of the DK, LT, and LV WWTPs. The use in EE, DE, and PL varied between 67% and 80%.
- **Secondary treatment:**
Almost all WWTPs used conventional aerated sludge treatment with nitrification and denitrification.
- **Tertiary treatment:**
The majority of the participating WWTPs (~ 60%) do not use another treatment step after the secondary clarifier. About a quarter of the WWTPs use post-filtration processes (e.g. sand filters, multi-media filters, disc filters) that are sometimes also used for post-denitrification. In detail: about half of the WWTPs in DE, FI and LT had filtration processes, whereas this was the case for about 20% of the WWTPs in DK, EE, and SE. None of WWTPs in LV and PL had post-filtration. Wastewater disinfection is very atypical (n = 4) and sometimes only used during a certain part of the year.

As WWTPs are often subject to stricter discharge limits, treatment processes have to be improved by time to time. Therefore, WWTPs were also asked to indicate their interest in the implementation of further measures within the next 5 years to improve the treatment capacity of their WWTP. In brief:

- About 2/3 of the WWTPs indicated interest in further measures. The most frequently mentioned targets were further nitrogen (N, 42%) and phosphorous (P, 37%) reduction. Further carbon (C) reduction and water reuse were each mentioned by 19% of the WWTPs, and disinfection by 11% (Figure 7). The lowest interest in further measures was in DE (no WWTP) and about 40% of the WWTPs in DK and FI also had no interest in further measures.
- WWTPs in EE indicated the most interest in further COD reduction (67%), whereas the interest varied between 10% and 21% in the all other countries (except DE).
- The highest interest in further N reduction was seen for WWTPs in EE (67%), SE (75%), and LT (100%), whereas this was the case for 33% - 40% of the WWTPs in DK, FI, LV, and PL.
- Further P reduction was marked by >50% of the WWTPs in EE, LV and SE and <34% of the WWTPs in DK, FI and PL.
- Water reuse appears to be of some interest in LV, DK, PL, and EE (17% - 33%), whereas interest is lower in SE (13%), FI (8%) and DE (0%). One of the two LT WWTPs is also interested in this topic.
- Disinfection was interesting for DK (6%), EE (17%), FI (25%), and PL (30%) WWTPs.

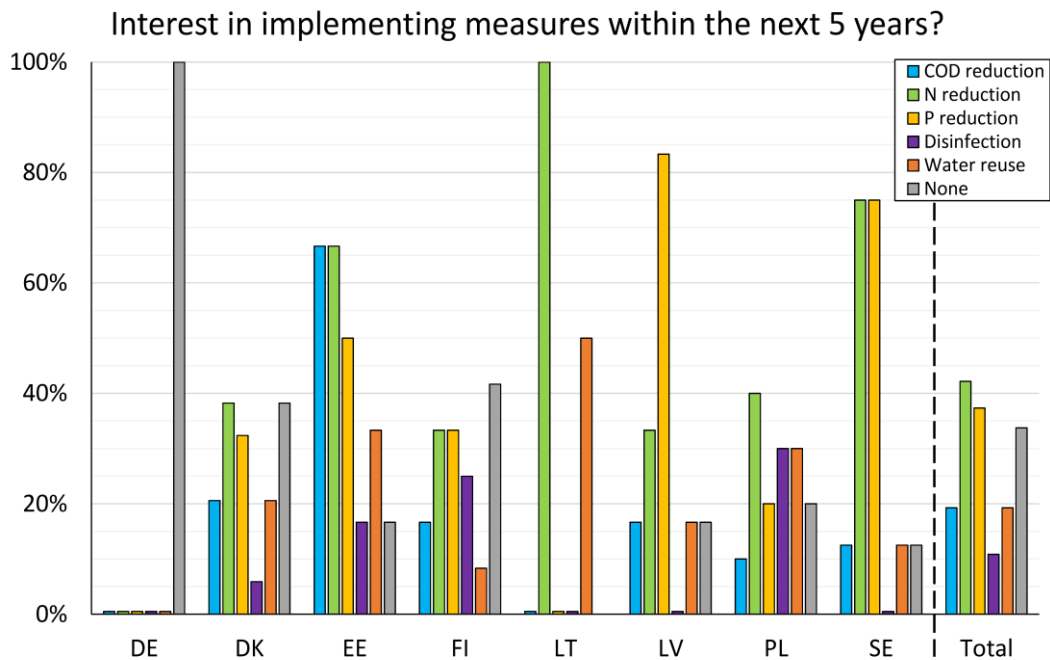

Figure 7: Questionnaire feedback regarding interest in implementing measures within the next five years (multiple choice answer possible).

Data availability for specific water quality parameters

As described in the introduction, certain water quality parameters are of particular relevance for designing an ozonation or activated carbon process. To determine whether and with what frequency these parameters are measured in the different countries, the questionnaire asked WWTPs to provide data on pH, temperature, total suspended solids, DOC, total and dissolved COD, nitrite, and bromide. Overall data availability is shown in Figure 8, whereas country wise figures can be found in **Appendix B**. Note that data gaps can have several reasons: the parameter is not measured in the secondary or WWTP effluent, the WWTP operator did not want to provide these data (even if they are measured), or parameters were confused with other ones (in a few cases).

In total, typical WWTP parameters such as water temperature, pH and total suspended solids (TSS) were available in most of the countries. Total chemical oxygen demand (COD) was also almost always available, whereas very few WWTPs also measure the dissolved COD. A possible explanation might be that only total COD is relevant for requirements of the WWTP effluent water quality, but also because the dissolved fraction could be estimated by considering the TSS concentration of the water.

In total, about 40% of the participating WWTPs provided data for nitrite (not to be confused with nitrate). In detail, nitrite was always measured in DE and LT, and by 58% to 67% of the WWTPs in FI, PL, LV, and EE. In contrast, nitrite values were only available at 25% of the SE and 15% of the DK WWTPs.

The lowest data availability was seen for dissolved organic carbon (DOC) and bromide, which is not surprising as both parameters are not commonly measured in wastewater. Only a few WWTPs from DE, EE, PL, and SE provided DOC measurement data, and only a few WWTPs from DK, EE and SE provided bromide data. Bromide values were also sometimes based on single samples.

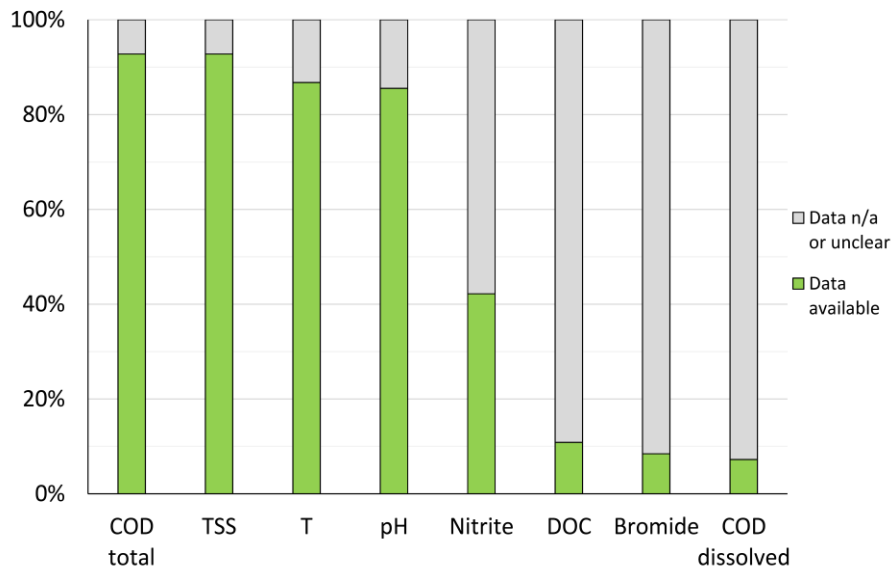

Figure 8: Data availability of selected water quality parameters at all participating WWTPs.

APIs: Experiences and motivation

Over 90% of the participating WWTPs were interested in measuring APIs in their effluent, with ~50% already having done so. Only a small fraction (<10%) of the WWTPs were uninterested in measuring APIs (Figure 9). More than 50% of the WWTPs in DE, EE, FI, LT (n = 1!), and SE indicated that they had already measured APIs, whereas this was the case for less than a third of the WWTPs in DK, LV and PL. The reported 100% API knowledge in Finland can likely be attributed to large API measurement campaigns at WWTPs coordinated by the Finnish Water Utilities Association in 2014 and 2020.

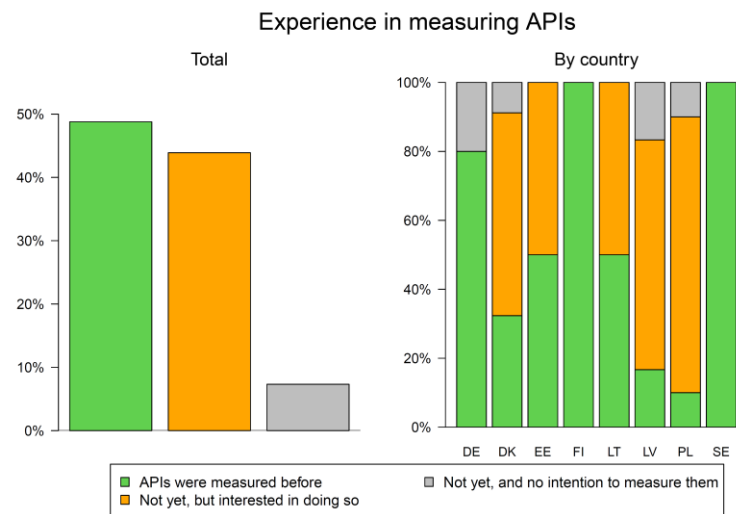

Figure 9: Current experience with measuring API concentrations by country.

When asked about what did or what would motivate WWTPs to reduce their API discharges, the most common answers were the general reduction of API emissions (~ 67%) and surface water protection (~50%), whereas drinking water protection (~ 8%) and other reasons were reported less frequently (8% and 13%, respectively). The category 'other' included bacteria and microplastic reduction, no interest in removal due to large foreseen investment costs, 'cleaner' sludge for agriculture, legal obligation to treat hospital wastewater for pharmaceutical removal (more efficient than treating at the hospital WWTP), and environmental protection.

Interestingly, Denmark was the only country that indicated a higher interest in a general API reduction than reduction for surface water protection. About 16% of the WWTPs indicated no interest in measures for API reduction, but only in FI, DK, EE and PL. In contrast, drinking water protection was only of interest in DE, SE, PL and FI. Details are shown in Figure 10.

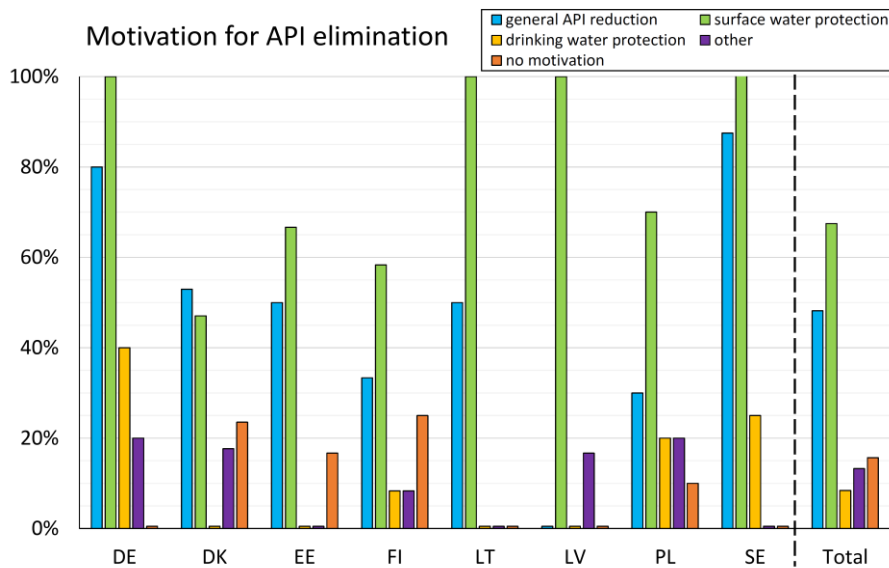

Figure 10: Motivation for API reduction (multiple choice answer possible).

When asked about which barriers prevent implementation of API removal technologies, legislative (~ 90%) and financial (~ 70%) barriers were mentioned most often, with lack of knowledge and water quality mentioned less frequently (~ 40%, each), and capacity problems mentioned the least (~20 %). Details are shown in Figure 11.

In detail, some WWTPs specified that they can't start planning API treatment processes as they don't have a legal obligation to do so or that there are uncertainties about which APIs to target on ('we don't want to upgrade WWTPs for treatment of "the wrong" micropollutants'). Some WWTPs also mentioned that they expect new demands in the future and that the legislation is currently changing in DK. The financial barriers can easily be explained by the increase of the treatment costs which needs to be clearly justified. Some WWTPs expect that the treatment costs will be very high. Regarding water quality barriers, some WWTPs highlighted that they need more information on API concentration in their treated and untreated wastewater. Lack of space for installing further treatment at the WWTP is also a relevant problem, especially for WWTPs built into rock or underground (e.g. in SE or FI). Regarding knowledge gaps, WWTPs mentioned uncertainties about potential negative impacts of API treatment technologies (e.g. ozonation is creating transformation products), risk of adverse environmental impacts (e.g. carbon footprint) as well as the lack of reference demonstration plants.

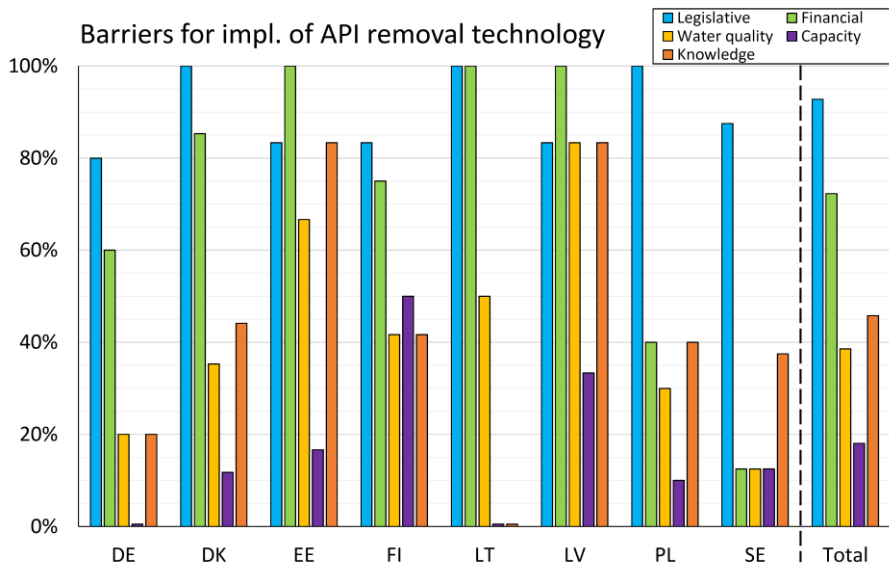

Figure 11: Barriers currently preventing implementation of API removal technologies (multiple choice answer possible).

Analysis of water samples received

It is worth repeating that the quantity of WWTPs responding varied greatly between countries. The countries can be split into two groups: those which sent numerous WWTP samples (DK = 34, FI = 11, SE = 8, PL = 10), and those which sent 6 or less samples (LV = 6, EE = 6, DE = 5, LT = 2). Additionally, results presented in this section are based on a single grab or mixed sample from each WWTP taken in the summer (May-July) and are therefore not representative of the annual WWTP operation. Most of the results are shown as boxplots. Directions for reading the boxplots are given in SI-Figure 10.

Chemical oxygen demand (COD)

The median COD_{tot} varied between 34 and 43 mg/L, when excluding LT (Figure 12). Two outliers above 200 mg/L were measured (1 x PL, 1 x SE, not shown) which could be explained with elevated particle concentration (highly visually turbid samples). When evaluating the dissolved COD fraction (COD_{dis}), the median value varied between 29 and 38 mg/L (Figure 13). The COD_{dis} outliers for DK and FI may be attributed to the high share of industrial wastewater, whereas the LV outlier was attributed to a WWTP with a medium share of industrial wastewater. Overall, results suggest that the organic composition of the secondary or WWTP effluent notably varies among the Baltic Sea WWTPs and no distinct differences between the countries could be observed.

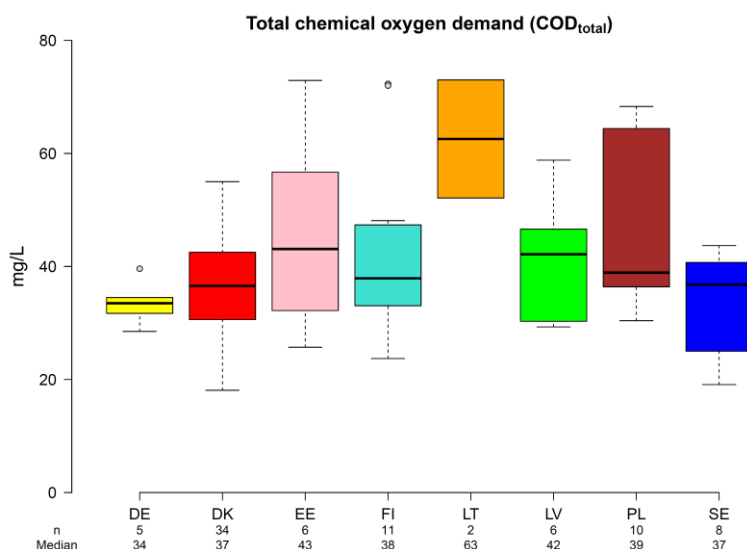

Figure 12: Total COD in analyzed samples.

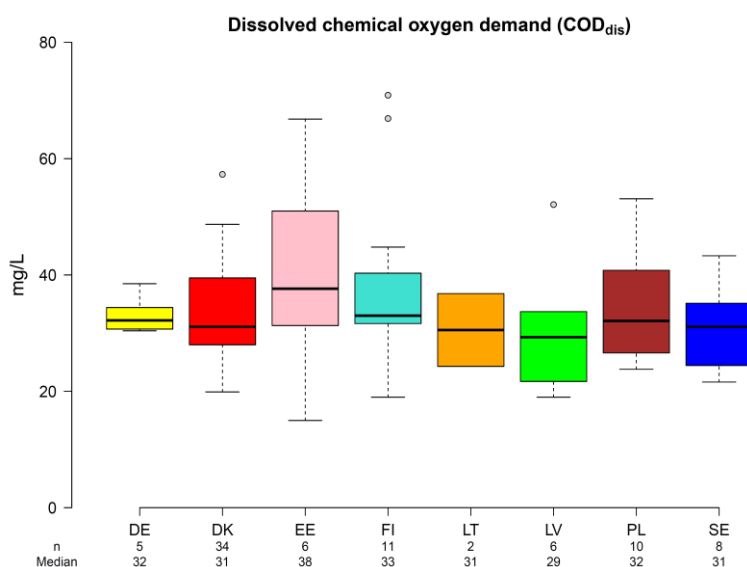

Figure 13: Dissolved COD in analyzed samples.

Dissolved organic carbon (DOC)

Apart from EE and LT, median DOC concentrations in the wastewater samples from each country were similar and varied between 11.3 and 12.5 mg/L (Figure 14). In comparison, median DOC concentration in the samples from EE (14.9 mg/L) and LT (14.1 mg/L) was higher. But even though median DOC concentrations appear to be similar between the countries, they still can vary strongly within the same country (e.g. DK with DOC concentrations between 7.8 and 19.5 mg/L). Thus, each individual WWTP should measure their DOC concentration before more detailed planning of an API elimination treatment.

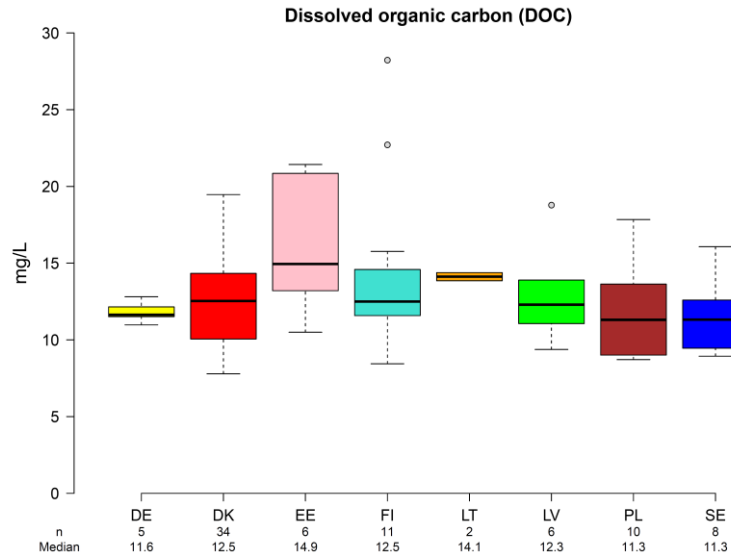

Figure 14: DOC concentrations in analyzed samples.

As previously shown, more than 80% of the WWTPs which participated in this study did not measure (or report) DOC. To make use of existing WWTP data, COD was evaluated as a surrogate for DOC. Thus, correlations between DOC and COD (both dissolved and total) were calculated using the entire dataset without outliers ($COD_{tot} > 100$ mg/L). The correlations in Figure 15 demonstrate that they provide a good estimate of what the DOC concentration could be if DOC is not regularly measured at the WWTPs. Not surprisingly, DOC correlates better with COD_{dis} (as the influence of particles is removed) than with COD_{tot} . Therefore, a COD to DOC ratio of about 3 could be used, regardless of whether based on total or dissolved COD.

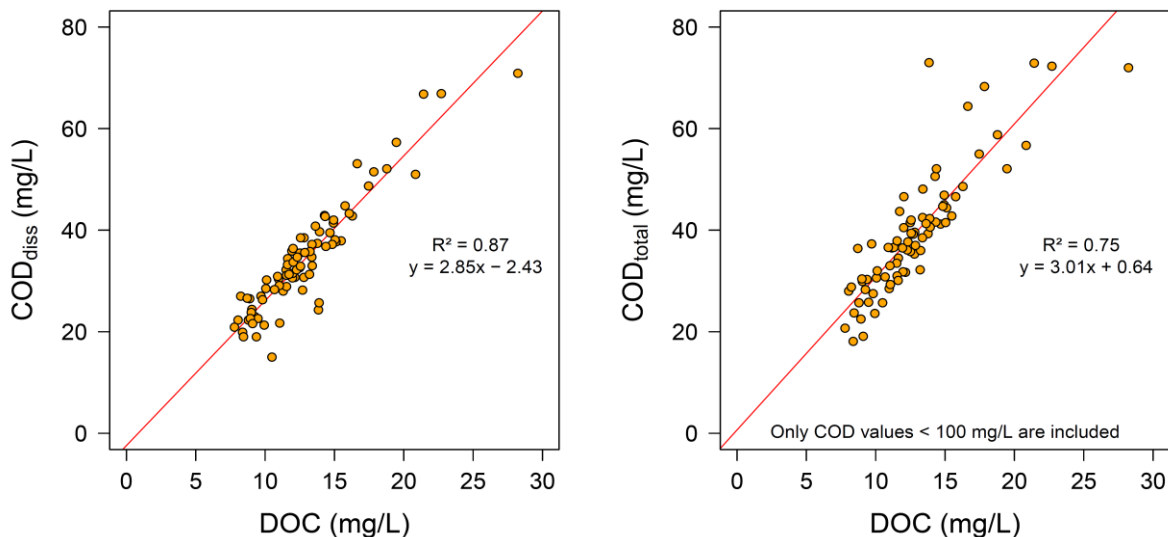

Figure 15: Correlation between DOC and total and dissolved COD.

Ultraviolet absorption at 254 nm (UVA₂₅₄)

Another potential surrogate for DOC could be UVA₂₅₄. Median UVA₂₅₄ values ranged between 24 and 30 1/m (Figure 16). The highest UVA₂₅₄ values were measured in samples from EE and FI with WWTPs that have a high share of industrial wastewater.

For a better comparison, specific ultraviolet absorbance (SUVA) can be derived by normalizing the UVA₂₅₄ to the DOC concentration, which indicates the aromaticity of the water. A higher SUVA is associated with more aromatic bonds in the organic compounds present in the water sample and vice-versa. Figure 17 shows that the median SUVA varied usually between 1.9 and 2.3 L/(mg*m) with only a few WWTPs samples outside this range. These results could be used as a simple surrogate to estimate the DOC concentrations (e.g. using the overall SUVA of ~2.2 L/(mg*m)) or to assess if the organic water composition is much higher/lower compared to the other WWTPs in the same region. This could be the case if the WWTP treats relevant amounts of industrial wastewater that is distinct from municipal wastewater and might affect the efficiency of the API treatment processes.

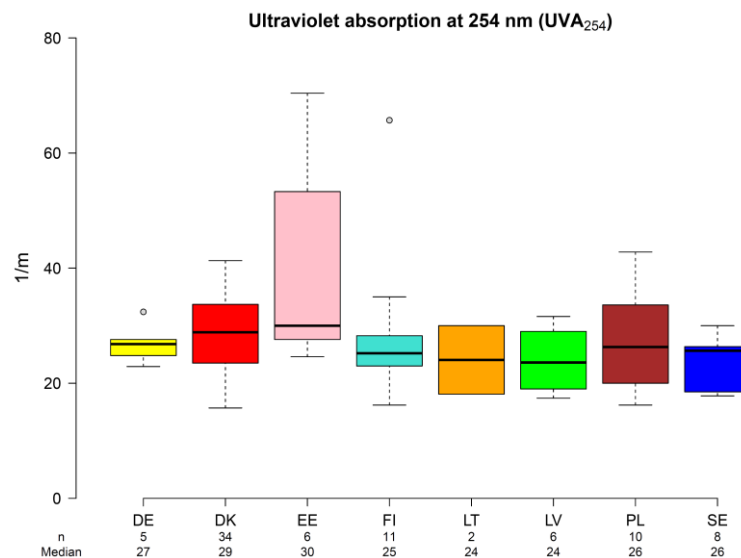

Figure 16: UV absorbance at 254nm (UVA₂₅₄) in analyzed samples.

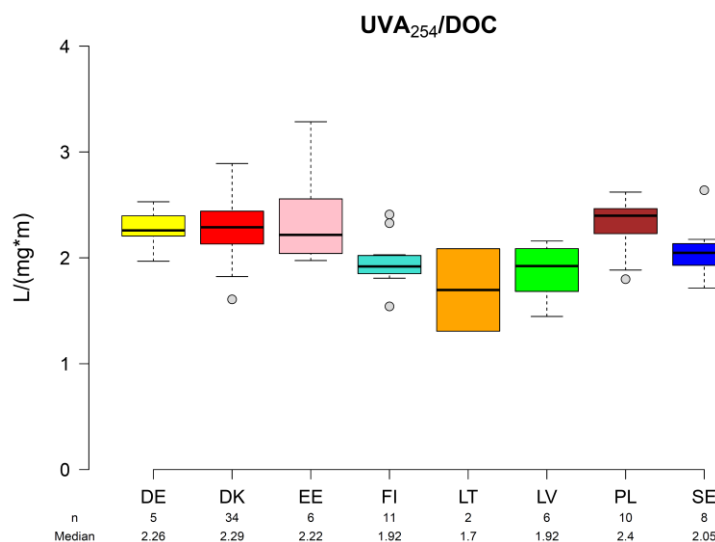

Figure 17: SUVA of the analyzed samples.

Nitrite

Nitrite, often confused with nitrate, is an intermediate product of the nitrification as well as the denitrification process and in most cases low in the WWTP effluent. This can also be seen by the nitrite concentrations of the water samples, which were in most cases below 0.1 mg-N/L (Figure 18). Two of the elevated nitrite concentrations (PL, SE) might also be explained by

biological processes in water samples because the overnight transport failed and the samples arrived warm. Also it should be kept in mind that the nitrite concentration can vary strongly at the WWTPs, if the nitrification/denitrification processes are disturbed (e.g. very low water temperatures, issues with aeration). Thus, nitrite should be measured regularly to get a valid data basis to estimate its potential impact on the overall ozone demand.

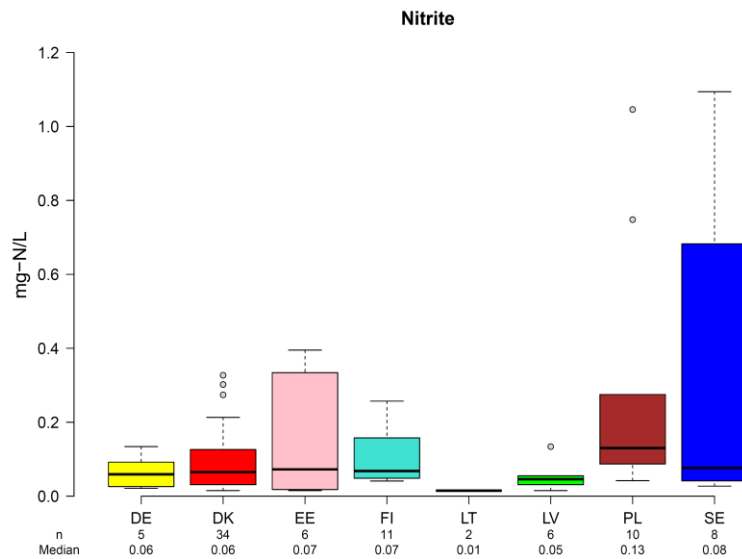

Figure 18: Nitrite concentrations of the analyzed samples.

Bromide

Bromide is of particular importance for ozonation as it can be transformed into bromate. At typically applied ozone doses, bromate formation is very low when bromide levels are below 150 µg/L. At higher bromide levels, potential bromate formation should be checked in lab-scale tests if ozonation is being considered by the WWTP. Based on the sample analysis, bromide concentrations were below 150 µg/L in most countries (red line in Figure 19), except for DK and EE, which revealed elevated bromide concentrations.

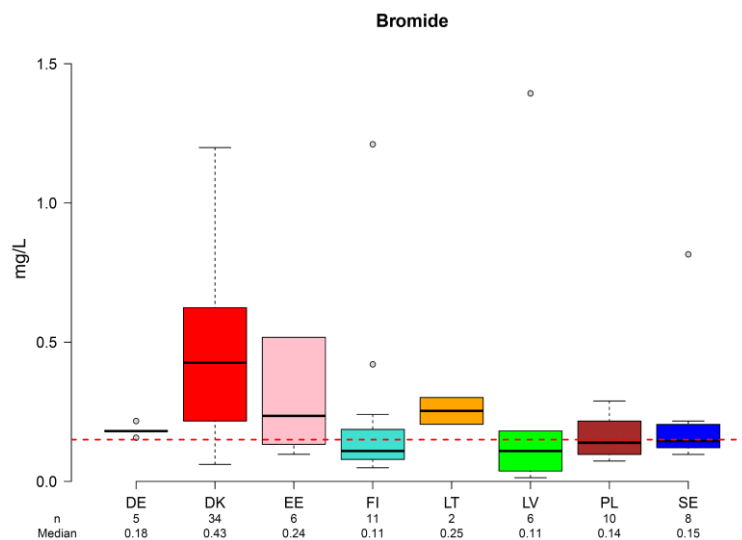

Figure 19: Bromide in analyzed samples. Red line indicates a bromide concentration of 0.15 mg/L.

Possible explanations for high bromide concentrations in the wastewater can be treatment of bromide containing industrial wastewater (one WWTP in DK had bromide levels considerably above 100 mg/L) or seawater intrusion into the sewer systems or drinking water sources. Therefore, the distance of the WWTPs to the coast was estimated via online maps and split into three categories: i) coastal (distance to sea < 5 km), ii) transition (5 – 20 km), and iii) inland (≥ 20 km). As expected, highest bromide concentrations were found in the coastal category,

whereas only a few inland WWTPs showed elevated bromide concentrations. It should, however, be recognized that salinity in the Baltic Sea is not only low compared to the open oceans (around 35 PSU⁶), but also has a strong salinity gradient. For example, salinity in the surface water of the Kattegat is around 20 PSU, whereas salinity is around 1 – 2 PSU in the parts of the Bothnian Bay and the Gulf of Finland⁷. Thus, it can be expected that similar shares of sea water in the wastewater can have a different impact on the bromide concentration depending on the local salinity level.

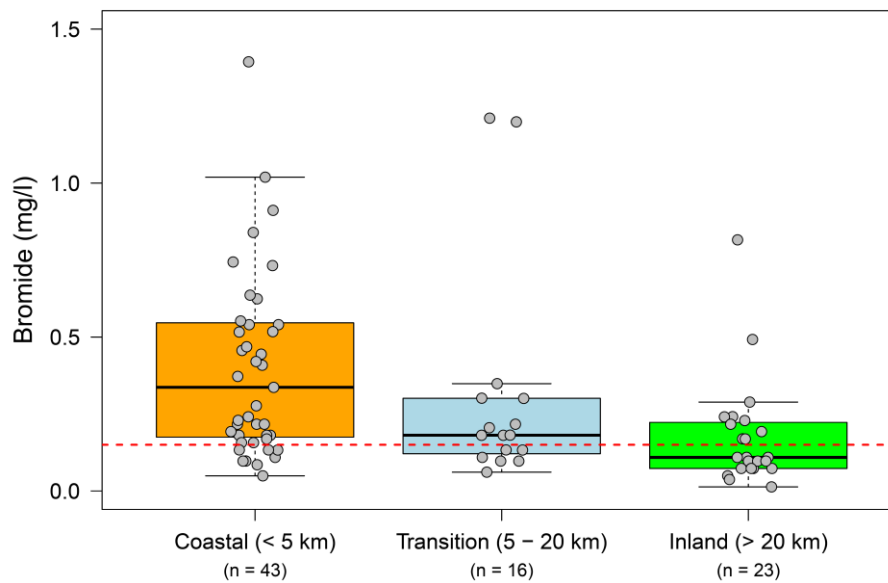

Figure 20: Relationship between bromide concentrations and distance to coast. Bromide concentrations above 1.5 mg/L are not shown.

Conductivity

As surrogate for sea water intrusion, samples were also evaluated for conductivity. In general, conductivity in the samples ranged widely, even though outliers (4,220 and 31,400 $\mu\text{S}/\text{cm}$) at two DK WWTPs are not shown in Figure 21. Highest conductivity values (median: 1,055 – 1,500 $\mu\text{S}/\text{cm}$) were found in the samples from DK and the three Baltic States WWTPs, whereas conductivity values were much lower in the other countries (median: 366 – 659 $\mu\text{S}/\text{cm}$).

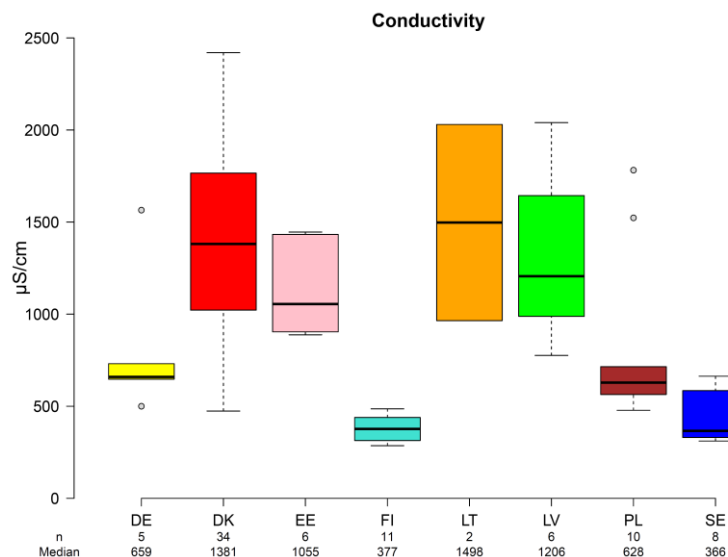

Figure 21: Conductivity in analyzed samples.

When assessing whether a relationship between conductivity and bromide exists, no clear trend for all WWTPs could be established (Figure 22). However, if only coastal WWTPs are taken into

⁶ PSU (Practical Salinity Units) is dimensionless and is equivalent to 1 g/kg (or 1 ‰) of salt in the water.

⁷ http://archive.iwlearn.net/helcom.fi/environment2/nature/en_GB/salinity/index.html, accessed: 07.12.2021

account, a correlation between conductivity and bromide becomes visible. However, further, more detailed investigations are required to verify the potential link between conductivity, sea water intrusion and bromide concentrations.

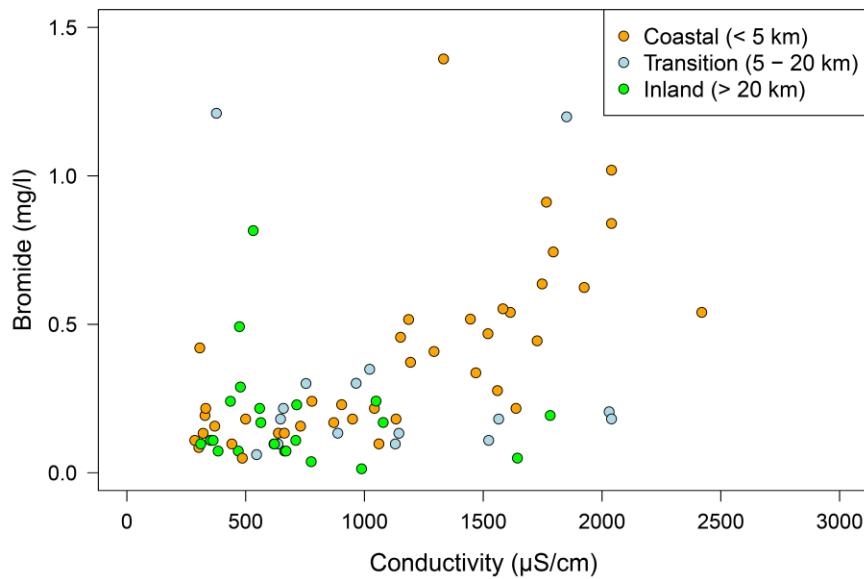

Figure 22: Relationship between bromide and conductivity. Very high bromide concentrations (> 1.5 mg/L) and conductivity (> 3000 $\mu\text{S}/\text{cm}$) are not shown in this figure.

APIs

As all surveyed countries have different approaches to selecting which APIs are regionally or even individually relevant, discussing the significance of API presence in this report is challenging.

Therefore, six APIs which are commonly measured when evaluating API removal technologies, namely carbamazepine, diclofenac, iopromide, metoprolol, tramadol and venlafaxine are depicted in Figure 23 and discussed as exemplary situations. The figure clusters the API concentrations in WWTP effluents by country, along with the total number of samples, the median concentration and the limit of quantification (LOQ) in $\mu\text{g}/\text{L}$. The concentration ranges between countries notably varies, but provides an idea of which APIs could be of greatest concern for surface waters receiving WWTP effluent. The predicted no effect concentration (PNEC) values, denoted by a red dotted line, allow a quick comparison of the API concentration to concentrations protecting surface water and aquatic life. Note that all samples were taken in summer (June/July). Thus, concentrations of APIs which have a seasonal consumption pattern (e.g. higher pharmaceutical consumption in winter compared to summer) might be distinctly different when repeating the sampling at another time of the year.

The results for all measured APIs ($n = 35$) can be found in the appendix, summarized by compound (**SI-Figure 1**) or country (**SI-Figure 2 - SI-Figure 5**). Additionally, information on APIs and used PNEC values can be found in **SI-Table 1**. Note that for a few APIs (azithromycin, candesartan, ciprofloxacin and roxithromycin) sensitivity of the analytical method varied and, thus, the according LOQ can differ between the countries.

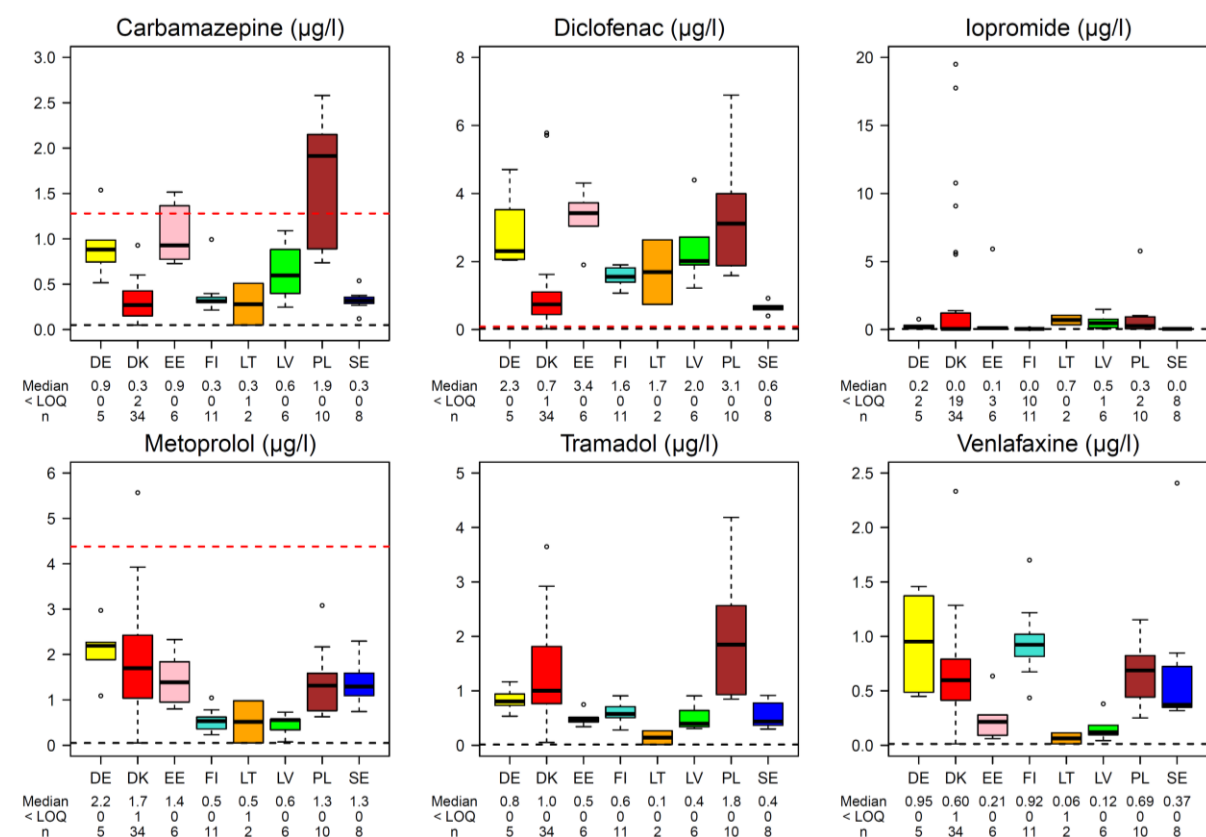

Figure 23: Concentration distributions for carbamazepine, diclofenac, ibuprofen, metoprolol, tramadol and venlafaxine at the different WWTPs. The black dotted line denotes LOQ concentrations, and the red dotted line denotes the predicted no effect concentration (PNEC) which was taken from prior CW Pharma project results (Ek Henning et al., 2020).

API concentrations above the PNEC in the environment indicate a potential threat to aquatic life, even though the dilution of the WWTP effluent by the receiving water body also has to be considered. In the worst case scenario (no dilution of WWTP effluent), API concentrations would exceed the PNEC for four APIs in all countries: clarithromycin, diclofenac, propranolol, and sulfamethoxazole (Table 2). Due to the PNEC of $\sim 0.1 \mu\text{g/L}$ for diclofenac, even a 20x dilution by the water body would not be sufficient for several WWTPs and, thus, API reduction technologies would be required. Other substances like carbamazepine, erythromycin, and ibuprofen could pose a risk in a few countries, whereas other substances like metoprolol could be more relevant for individual WWTPs. In contrast, PNEC values of tramadol ($170 \mu\text{g/L}$) and venlafaxine ($3.22 \mu\text{g/L}$) are notably greater than concentrations found in the samples and, thus, are not considered to be relevant. A summary of the RQs by country is available in the appendix (SI-Figure 6 - SI-Figure 9).

Table 2: APIs with relevant concentrations (median of risk quotient > 1). Note: clindamycin is not shown here, because only individual samples were above LOQ. Risk quotient was determined by dividing median API concentration by PNEC value.

API	DE	DK	EE	FI	LT	LV	PL	SE
Carbamazepine							X	
Clarithromycin	X	X	X	X	X	X	X	X
Diclofenac	X	X	X	X	X	X	X	X
Erythromycin	X							
Ibuprofen			X	X			X	X
Propranolol	X	X	X	X	X	X	X	X
Sulfamethoxazole	X	X	X	X	X	X	X	X

Evaluation for the individual fitness-check

Data availability

DOC is the most common design parameter for determining the required ozone or PAC dosage. Therefore, if DOC is not measured at the WWTP (which applies to most WWTPs), it is recommended to start measuring DOC over a longer period to identify potential variations throughout the year. Additionally, WWTPs could make use of existing COD data by estimating the according DOC with a local or general (see section above) DOC/COD ratio.

In case ozonation is being considered, then regular measurement of nitrite and bromide is strongly recommended.

Expected dosages of ozone or PAC

As a first estimate, the required ozone and PAC doses were estimated based on the DOC concentration in the water sample and typical specific doses (ozone = 0.3 – 0.7 mgO₃/mgDOC, PAC = 1 – 2 mg/L). Additionally, the impact of nitrite on the overall ozone demand was considered by using the nitrite concentration in the water samples and (if available) in the WWTP effluent.

Barriers

Industrial wastewater (IWW)

WWTPs that treat primarily municipal wastewater (IWW shares < 10 %) are expected to achieve similar API eliminations when typical specific dosages (ozone, PAC) or GAC exchange frequencies are used. Increasing the IWW shares can impact the API elimination efficiency and, depending on the type of wastewater, could lead to unexpected behavior. So far, there are no comprehensive studies available that have evaluated the potential effects of different kinds of IWW. Thus, WWTPs which have elevated shares of IWW or are aware of industries with 'atypical' wastewater are recommended to carry out lab-scale tests with the local water matrix.

Excess sludge treatment (relevant for PAC)

Sludge treatment poses a barrier for the implementation of a PAC processes unless excess sludge is incinerated. Even though a PAC process with a separate PAC sludge cycle / treatment process (incineration) might be possible, overall PAC loading efficiency is expected to be lower. Sludge treatment does not have an impact on the implementation of ozonation and GAC filtration.

Bromide (relevant for ozonation)

Presence of bromide in the wastewater above 0.15 mg/L poses a barrier for ozonation, but does not affect PAC or GAC processes. Elevated bromide concentrations are often associated with the presence of relevant point sources (e.g. certain industries, waste incineration facilities, landfills) and the distance of the WWTP and/or according canalization to the sea. Intrusion of bromide containing sea water into the sewer system depends on local boundary conditions and can also be event specific. Thus, to achieve a good temporal coverage, long-term sampling campaigns are recommended instead of single samplings. If bromide concentrations are elevated but ozonation is still being considered, bromide source tracking can be carried out to identify potential reduction measures.

Interaction with other treatment goals

API elimination technologies can also often contribute achieving other wastewater treatment goals. To make use of potential synergy effects, evaluating the advantages and disadvantages of the different technologies is recommended early in the planning process.

Further C reduction

Ozonation (including post-treatment) as well as PAC and GAC processes result in significant COD reductions and can therefore contribute to an overall C reduction strategy.

Further N reduction

Activated carbon processes usually do not impact the nitrification and denitrification processes as long as the treatment plant can handle the additional mixed liquor suspended solids (MLSS) load. Ozonation usually does not interact with ammonium in the water, but transforms nitrite into nitrate (increases ozone demand). In addition, dissolved oxygen (DO) concentrations in the ozonation effluent increase to around 20 mg/L. Even though such high DO concentrations can be beneficial for post-nitrification processes, they can negatively affect post-denitrification processes.

Further P reduction

PAC processes often use coagulants (e.g. Fe, Al) to improve the PAC settling/separation, which also results in enhanced phosphorous removal. GAC filtration provides only limited P removal which is associated with TSS retention. Overall P reduction can be increased by dosing coagulants before GAC filtration. In contrast, ozonation does not significantly affect the P content in the water, but could be combined with a suitable subsequent coagulation filtration process that is also used as biological post-treatment.

Disinfection and water reuse

Water reuse and disinfection are closely linked, but can target different treatment goals (e.g. bathing water quality according to EU Directive 2006/7/EC or agricultural water reuse according to EU Regulation 2020/741). Although only ozonation provides direct water disinfection, all API elimination technologies increase the UV transmittance of the water, which is beneficial for potential subsequent UV disinfection processes. If a disinfection treatment process follows a filtration process (e.g. PAC/GAC), requirements for unrestricted water reuse could also be met.

Use of existing infrastructure

Synergies between already existing tertiary treatment stages and API elimination technologies should be checked. Around 25% of the participating WWTPs have post-filtration. Depending on the technical boundary conditions, they were assessed as:

- **Conventional filters (e.g. sand filter, multi-layer filters ...)**
Might be used as ozonation post-treatment or as a final PAC polishing stage. Additionally, replacing (some parts) of the filter material with GAC could be an option.
- **Denitrification filters**
Might be used as a final polishing after PAC, or (some parts) of the filter material could be replaced with GAC. However, operating such systems as denitrification processes is uncommon and therefore pilot trials would be recommended to evaluate the feasibility. Using such filters as ozonation post-treatment is not recommended due to the high DO concentrations.
- **Microsieve / disc filters**
Microsieves / disc filters have no biological activity and thus are not suitable for ozonation post-treatment. Also, PAC retention can be limited if these systems are used as a final polishing step, thus their potential use for this purpose should be carefully evaluated. Therefore, these filters are more suitable as pre-treatment to GAC filter (reduction of back-flushing intervals) or ozonation pre-treatment.

Summary

Overall, WWTP fitness-checks were conducted for about 80 WWTPs within the Baltic Sea region. Most WWTPs were located in the Nordic Region (n = 54; DK, FI, SE), followed by the South Baltic (n = 15; DE, PL) and the Baltic States (n = 14; EE, LT, LV). The fitness-checks are based on the feedback from the WWTP operator (questionnaire) and the analysis of a single wastewater sample. The wastewater sample was analyzed for several water quality parameters (e.g. COD, DOC, nitrite, bromide ...) and 35 APIs. The results of the individual fitness checks are only the first step towards implementing API elimination measures. Data gaps and potential barriers have been identified so that more focused investigations can be conducted. In general, more data acquisition is recommended, since this information is the basis of potential feasibility studies. In short:

- Evaluation of the questionnaires revealed that several water quality parameters, such as DOC (relevant for ozonation/activated carbon) and nitrite/bromide (relevant for ozonation) are seldom measured. For WWTPs interested in implementing API elimination technologies, it is therefore strongly recommended to start measuring these parameters.
- Evaluation of the water samples showed that there are no distinct differences of the median COD and DOC concentrations between the BSR countries, even though concentrations can vary strongly between the WWTPs in the same country. As a first estimate of DOC, surrogates such as the COD or the UVA₂₅₄ could be used.
- API concentrations at the WWTP effluents were summarized by substance and by country. These data allow a quick cross-check with API data from the local WWTP and to identify noticeable high or low API concentrations by comparison. Additionally, risk quotients were determined by comparing the API concentrations in the water samples to available predicted no effect concentrations (PNEC). Due to the limitations of this study (no representative sample, no dilution by the receiving water body), these risk quotients are only an initial estimate. Nevertheless, it can be a first step to identify the most relevant APIs for the WWTP. For example, APIs with median risk quotients > 1 in all countries were diclofenac, clarithromycin, propranolol and sulfamethoxazole.
- This study showed that several barriers for the implementation of API elimination technologies exist. For example, ozonation can be impeded by elevated bromide concentrations, which are often present at coastal WWTPs. PAC processes can be hindered by the current way of sludge disposal. Most of the participating WWTPs dispose of their sludge in agriculture, whereas only about 25% incinerate it. Besides these more technical barriers, also missing legal demands, high financial efforts, and uncertainties about the selection of the 'right' APIs were mentioned by several utilities as substantial barriers. Thus, these barriers need to be addressed by the relevant political players to promote the implementation of API removal technologies at municipal WWTPs (see also (Thisgaard et al., 2020; Zhiteneva et al., 2020)).
- WWTPs that plan to improve their treatment processes in the near future should also look at potential synergy effects with API elimination technologies (e.g. further C and P reduction). Also, investment costs for API elimination can be reduced if existing infrastructure (e.g. filter systems) can be used (e.g. as ozonation post-treatment, PAC polishing).

References

- Ek Henning, H., Putna-Nimane, I., Kalinowski, R., Perkola, N., Bogusz, A., Kublina, A., Haiba, E., Bārda, I., Karkovska, I., Schütz, J., Mehtonen, J., Siimes, K., Nyhlén, K., Dzintare, L., Äystö, L., Siņics, L., Laht, M., Lehtonen, M., Stapf, M., Stridh, P., Poikāne, R., Hoppe, S., Lehtinen, T., Kõrgmaa, V., Junntila, V. and Leisk, Ü. 2020 Pharmaceuticals in the Baltic Sea Region – emissions, consumption and environmental risks. CWPharma Activity 2.1 and 2.2 output, Länsstyrelsen Östergötland, Linköping.
- R Core Team 2021 R: A language and environment for statistical computing. Computing, R.F.f.S. (ed), Vienna, Austria.
- Rettig, S., Schulz, K., Barjenbruch, M. and Al-Zreiqat, I. 2018 Key Figure Data For Energy Efficiency. Benchmarking the Baltic Sea Region in the project IWAMA – Interactive Water Management.
- Stapf, M., Miehe, U., Bester, K. and Lukas, M. 2020 Guideline for advanced API removal. CWPharma Activity 3.4 output.
- Thisgaard, P., Zhiteneva, V., Miehe, U., Stapf, M., Perkola, N., Mehtonen, J., Äystö, L. and Ek Henning, H. 2020 Action Plan for API Emission Reductions. CWPharma Activity 5.3 output.
- Zhiteneva, V., Thisgaard, P., Miehe, U., Stapf, M., Perkola, N., Mehtonen, J., Äystö, L. and Ek Henning, H. 2020 Joint Conclusions for API Emission Reductions. CWPharma Activity 5.2 output., p. 22.

Appendix

- A) Questionnaire that was sent out to the WWTPs (English version)
- B) Data availability of water quality parameters
- C) API concentrations by substance
- D) API concentrations by country
- E) Risk quotients by country
- F) API overview
- G) How to read the boxplots



Wastewater treatment plant (WWTP) processes

Please check boxes or fill in numerical values. You can also use “Comments” or “Other” to provide additional information or clarification.

1. WWTP name, country & E-mail address for feedback to questionnaire	Name & country:		E-Mail address:		
2. Current population equivalents of WWTP (PE) and the average water volume treated	PE:		Wastewater volume (m ³ /year):		
3. Estimate the share of industrial wastewater in total wastewater treated (please note whether estimate is load or flow based)	<input type="checkbox"/> Loading <input type="checkbox"/> Flow	<input type="checkbox"/> Low (<10%) <input type="checkbox"/> Medium (10-30%) <input type="checkbox"/> High (>30%)	Comments:		
4. What are your average WWTP effluent concentrations and limits for - carbon (C), - nitrogen (N) and - phosphorous (P)? (Please comment, if discharge limits depend on other targets e.g. % reduction)	Measured average Limit		C (mg/L)	N (mg-N/L)	P (mg-P/L)
Comments:					
5. Which treatment processes are employed at your WWTP? (AD = anaerobic digestion; MBR = membrane bioreactor; MBBR = moving bed bioreactor)	Primary <input type="checkbox"/> Screening <input type="checkbox"/> Sand/grit removal <input type="checkbox"/> Sedimentation/clarifier <input type="checkbox"/> Other: _____	Secondary <input type="checkbox"/> Nitrification only (specify process): _____ <input type="checkbox"/> Nitrification and denitrification (specify processes): _____	Tertiary <input type="checkbox"/> None <input type="checkbox"/> AD <input type="checkbox"/> MBR <input type="checkbox"/> MBBR <input type="checkbox"/> Lagoon <input type="checkbox"/> Adsorption (carbon) <input type="checkbox"/> Filtration (elaborate): _____ <input type="checkbox"/> Other: _____	Disinfection <input type="checkbox"/> None <input type="checkbox"/> Chlorination <input type="checkbox"/> Ozone <input type="checkbox"/> UV <input type="checkbox"/> Other: _____	
6. Where does your treated sewage sludge end up?	<input type="checkbox"/> Incineration <input type="checkbox"/> Agriculture <input type="checkbox"/> Landscaping		<input type="checkbox"/> Other: _____		

Advanced wastewater treatment for pharmaceutical (API) removal

Please check boxes. You can also use "Other" to provide additional information or clarification.

<p>7. Are you interested in implementing any of the following measures within the next five years?</p>	<p><input type="checkbox"/> Further COD reduction <input type="checkbox"/> Further N reduction <input type="checkbox"/> Further P reduction <input type="checkbox"/> Disinfection <input type="checkbox"/> Water reuse <input type="checkbox"/> None</p>
<p>8. Have you measured API/pharmaceutical concentrations in the WWTP effluent?</p>	<p><input type="checkbox"/> Yes <input type="checkbox"/> Not yet, but interested in doing so <input type="checkbox"/> Not yet, and no intention to measure them</p>
<p>9. In the event of no legal obligation, for what end goal would you consider implementing an advanced wastewater treatment for pharmaceutical removal?</p>	<p><input type="checkbox"/> Reduce API emissions in general <input type="checkbox"/> Surface water protection (e.g. rivers, Baltic Sea) <input type="checkbox"/> Drinking water protection <input type="checkbox"/> Other: _____ <input type="checkbox"/> No personal motivation for doing so</p>
<p>Legislative</p>	<p><input type="checkbox"/> No demand by authorities to remove pharmaceuticals <input type="checkbox"/> Other: _____</p>
<p>Financial</p>	<p><input type="checkbox"/> No financial assistance from government <input type="checkbox"/> Other: _____</p>
<p>Water quality</p>	<p><input type="checkbox"/> No relevant API concentrations in wastewater <input type="checkbox"/> Need to comply with C/N/P/BOD concentrations first <input type="checkbox"/> Other: _____</p>
<p>Capacity</p>	<p><input type="checkbox"/> Not enough physical area in WWTP <input type="checkbox"/> Other: _____</p>
<p>Knowledge</p>	<p><input type="checkbox"/> Lack of know-how to implement such advanced wastewater treatment <input type="checkbox"/> Other: _____</p>
<p>10. Which existing barriers prevent you from implementing an advanced wastewater treatment for pharmaceutical removal?</p>	

Water quality parameters

Please provide average and/or range of concentrations for secondary effluent water quality parameters. If certain parameters are not measured in the secondary effluent, but in the WWTP effluent, please state these instead.

	Unit	Not measured	Secondary effluent	WWTP effluent	Comment
11. Total chemical oxygen demand (COD _T)	mg/L	<input type="checkbox"/>			
12. Dissolved chemical oxygen demand (COD _{DIS})	mg/L	<input type="checkbox"/>			
13. Dissolved organic carbon (DOC)	mg/L	<input type="checkbox"/>			
14. Total suspended solids (TSS)	mg/L	<input type="checkbox"/>			
15. Nitrite (NO ₂ ⁻)	mg-N/L	<input type="checkbox"/>			
16. Bromide (Br ⁻)	mg/L	<input type="checkbox"/>			
17. Water temperature	°C	<input type="checkbox"/>			
18. pH	-	<input type="checkbox"/>			
19. Would you be interested in sending us a water sample for analysis of certain water quality parameters as well as APIs? (No costs, results will only be used in anonymous form)					
				<input type="checkbox"/> Yes	<input type="checkbox"/> No

Please send the finalized questionnaire as word file or scan to: XXX@YYY.ZZZ

Appendix B: Data availability of water quality parameters

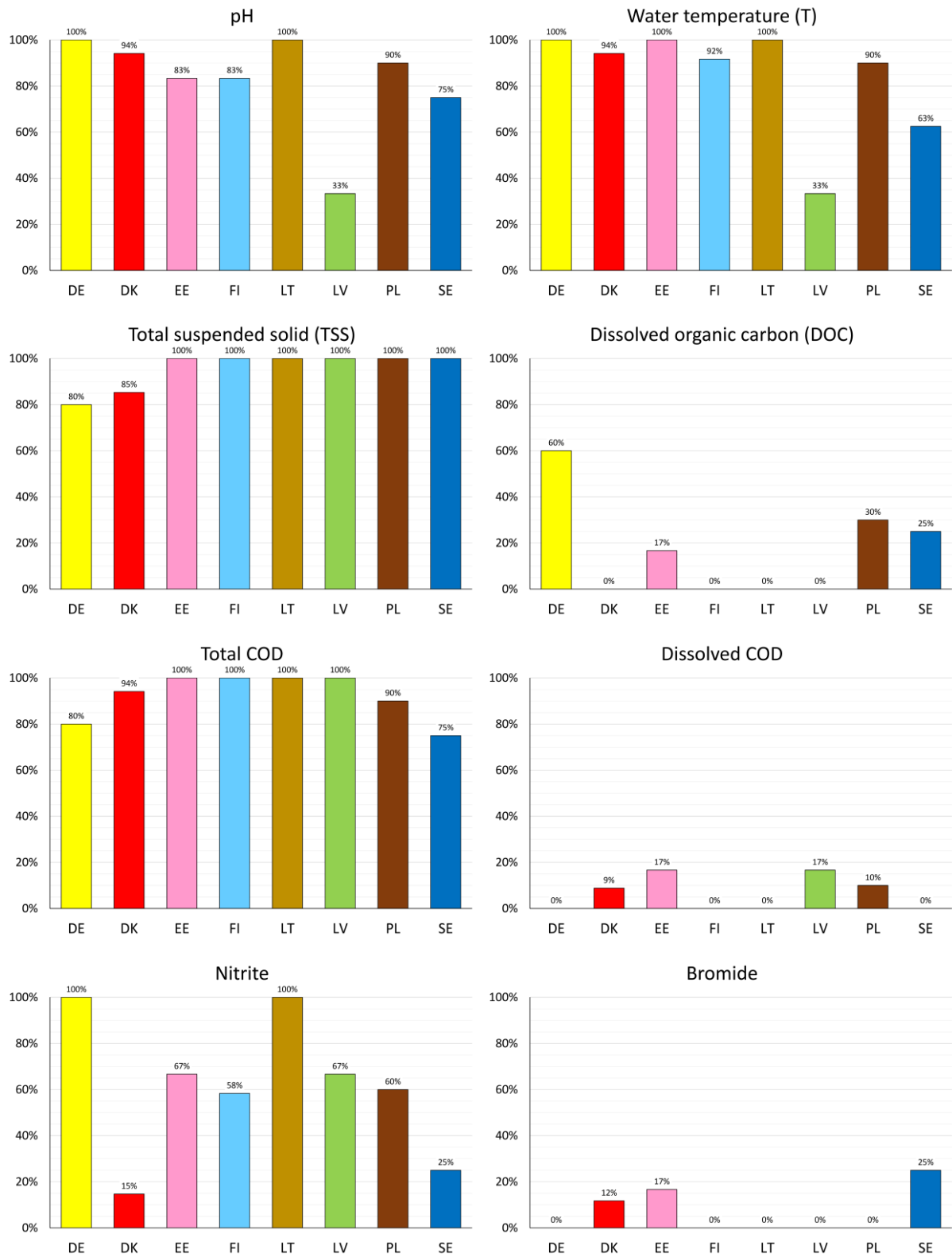

Appendix C: API concentrations by substance

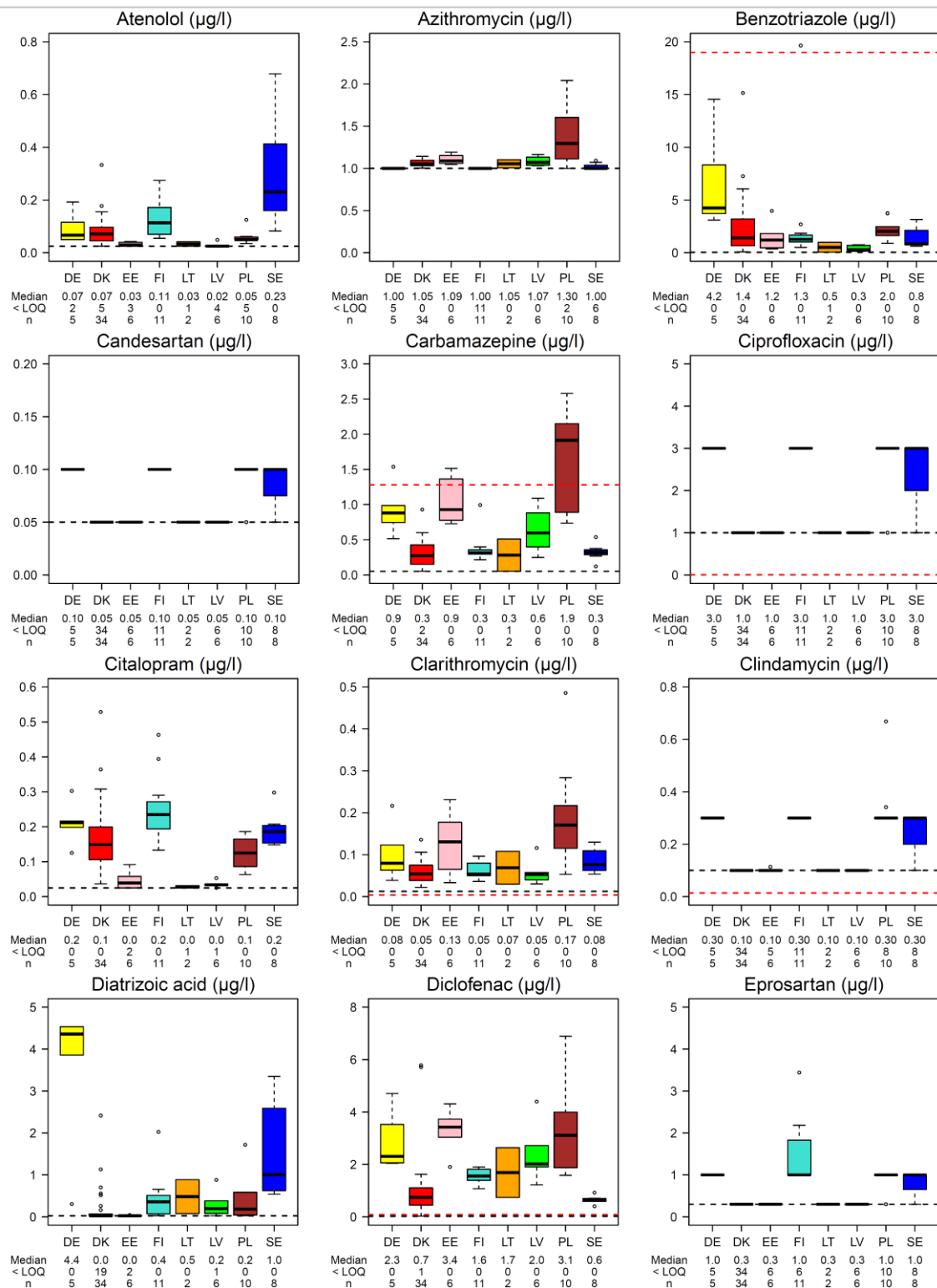

SI-Figure 1: Concentrations for all measured APIs in the WWPT effluents of the eight countries. The black dotted line denotes LOQ concentrations, and the red dotted line denotes the predicted no effect concentration (PNEC) which was taken from prior CWPharma results (SI-Table 1). Lack of a PNEC line means no either no PNEC values were available for this API or the PNEC value is outside (above) the plot. Single outliers not shown: Citalopram = 4.9 $\mu\text{g/l}$ (DK) and Diatrizoic acid = 7.6 $\mu\text{g/l}$ (PL), 8.1 $\mu\text{g/l}$ (SE), and 29.2 $\mu\text{g/l}$ (DE).

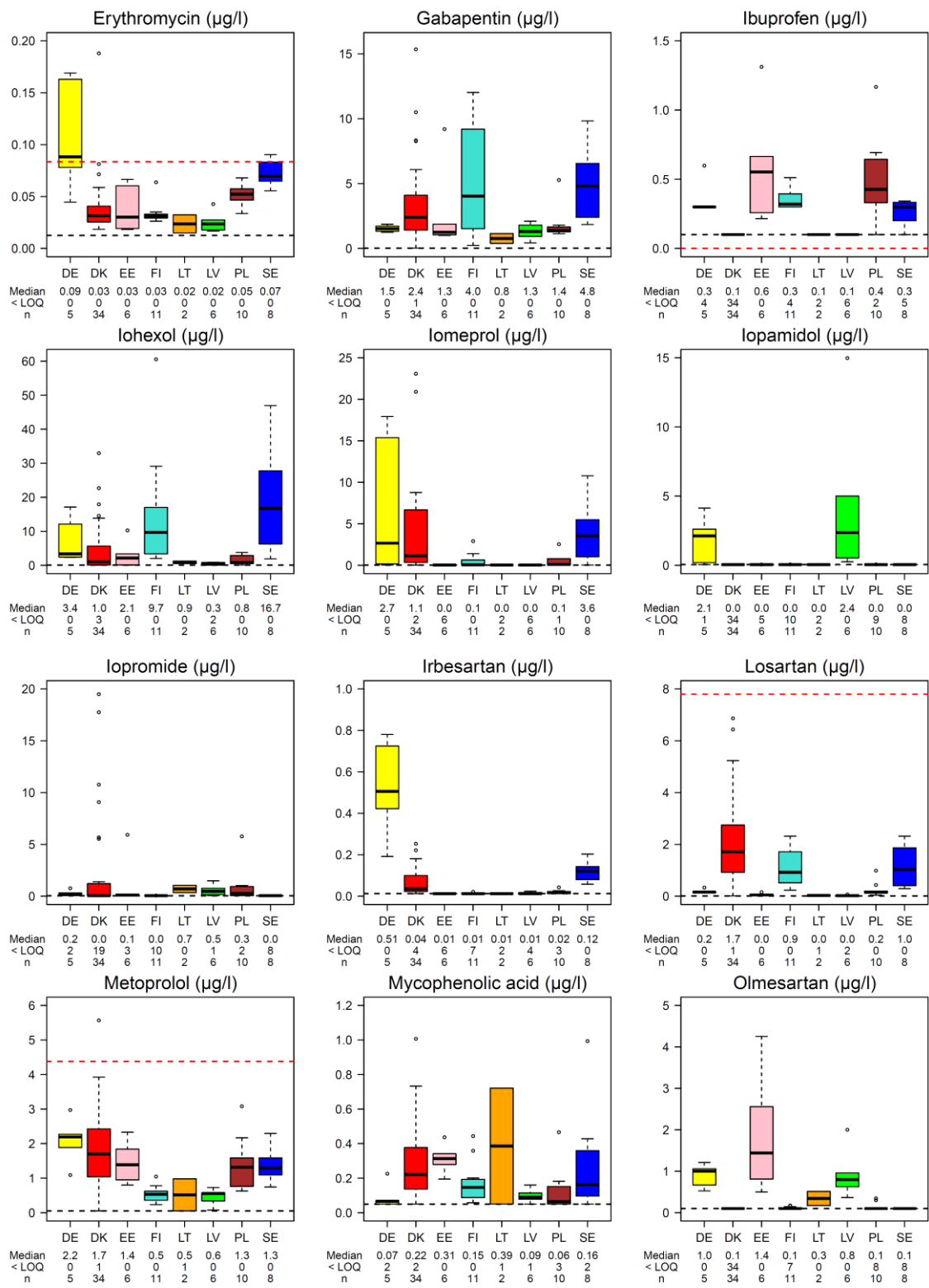

SI-Figure 1 (cont'd): Concentrations for all measured APIs in the WWPT effluents of the eight countries. The black dotted line denotes LOQ concentrations, and the red dotted line denotes the predicted no effect concentration (PNEC) which was taken from prior CWPharma results (SI-Table 1). Lack of a PNEC line means no either no PNEC values were available for this API or the PNEC value is outside (above) the plot. Single outliers not shown: Ibuprofen = 6.2 $\mu\text{g/l}$ (SE) and lomeprol = 49.7 $\mu\text{g/l}$ (DK) and 109 $\mu\text{g/l}$ (DK).

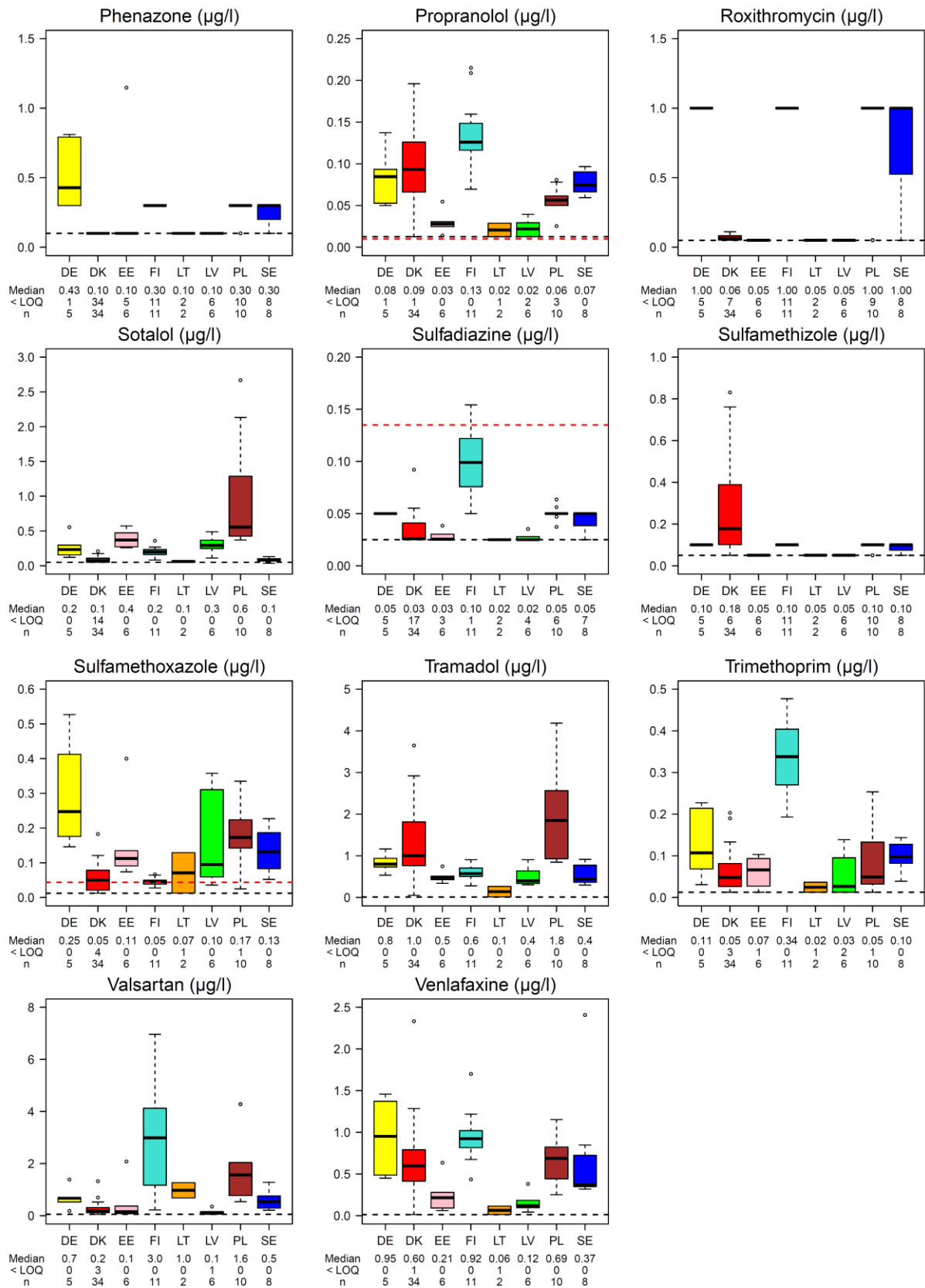

SI-Figure 1 (cont'd): Concentrations for all measured APIs in the WWPT effluents of the eight countries. The black dotted line denotes LOQ concentrations, and the red dotted line denotes the predicted no effect concentration (PNEC) which was taken from prior CWPharma results (SI-Table 1). Lack of a PNEC line means no either no PNEC values were available for this API or the PNEC value is outside (above) the plot.

Appendix D: API concentrations by country

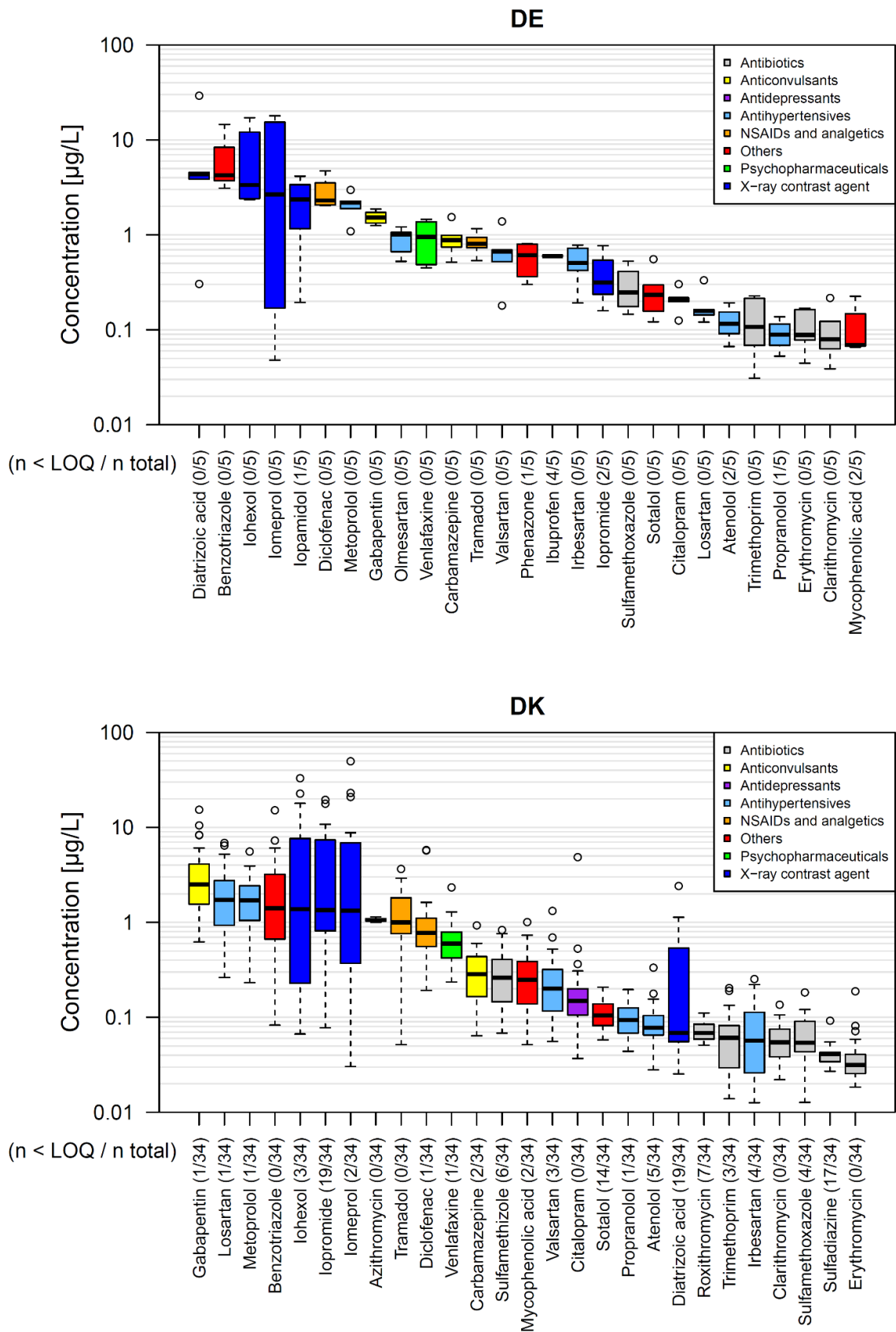

SI-Figure 2: Boxplot of the API concentrations for Germany (DE) and Denmark (DK) that have been measured in the wastewater samples. APIs that were below LOQ in all samples are not shown.

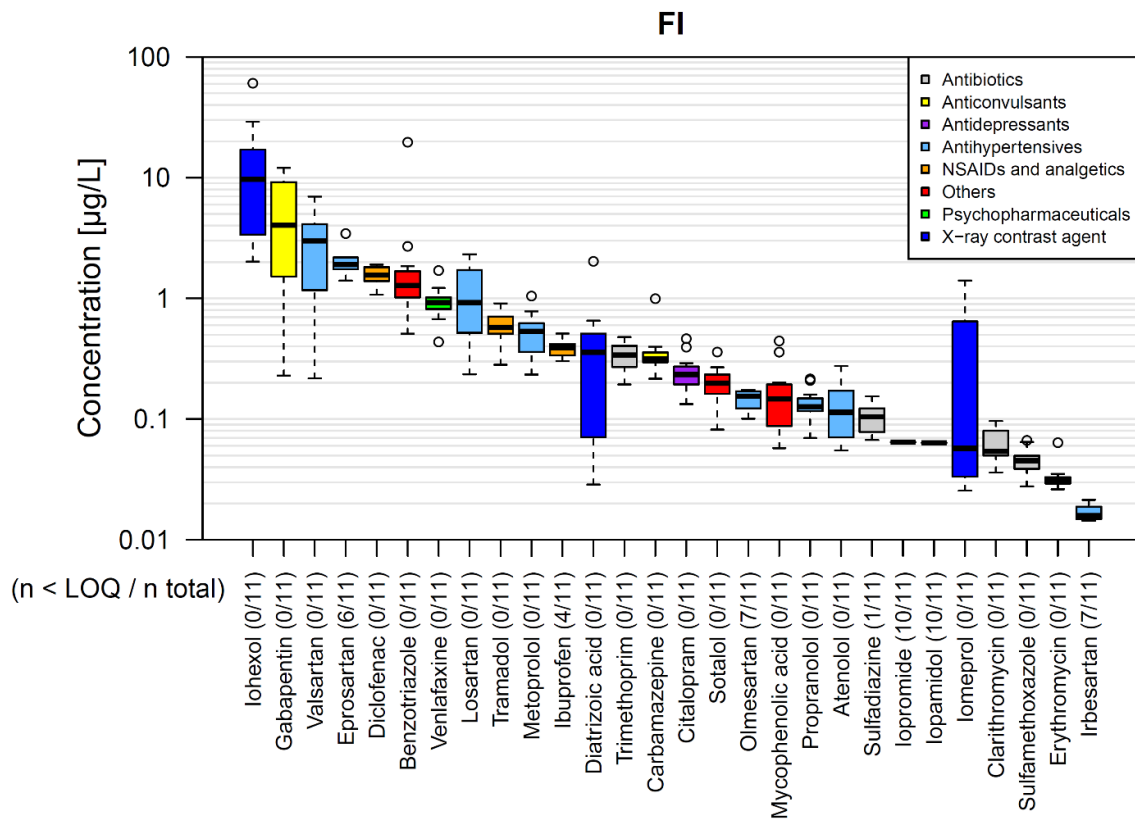
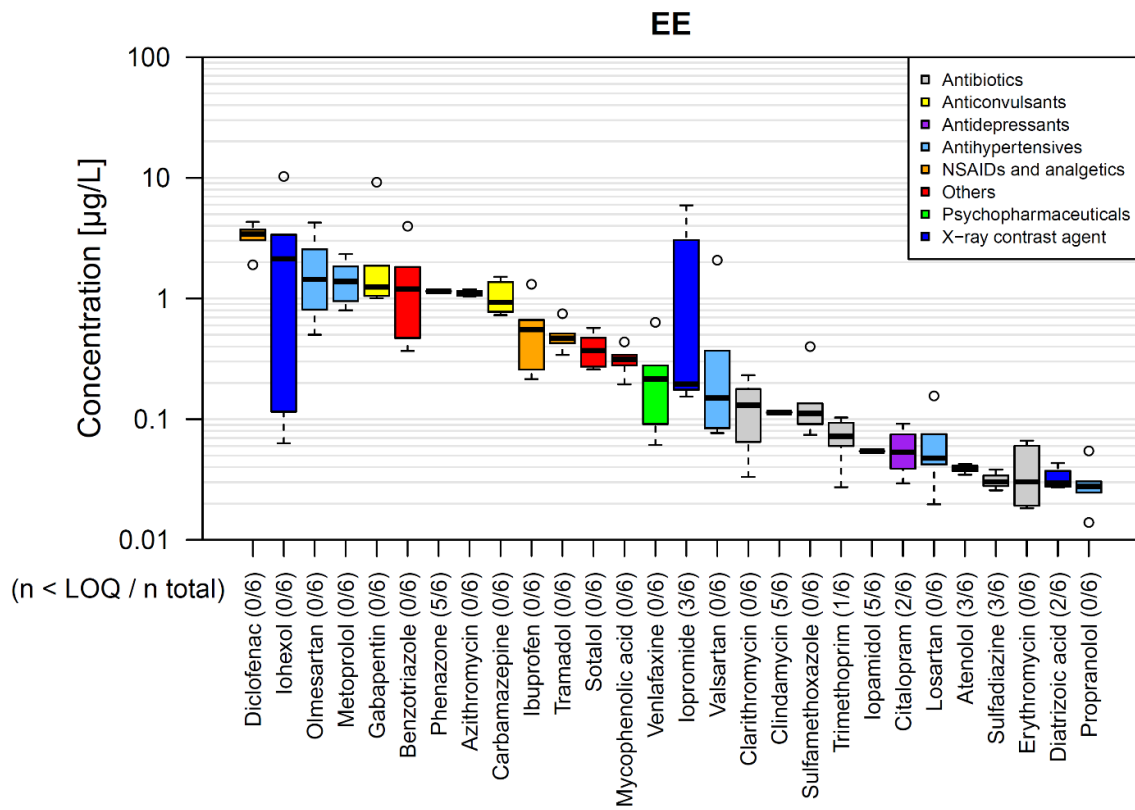

SI-Figure 3: Boxplot of the API concentrations for Estonia (EE) and Finland (FI) that have been measured in the wastewater samples. APIs that were below LOQ in all samples are not shown.

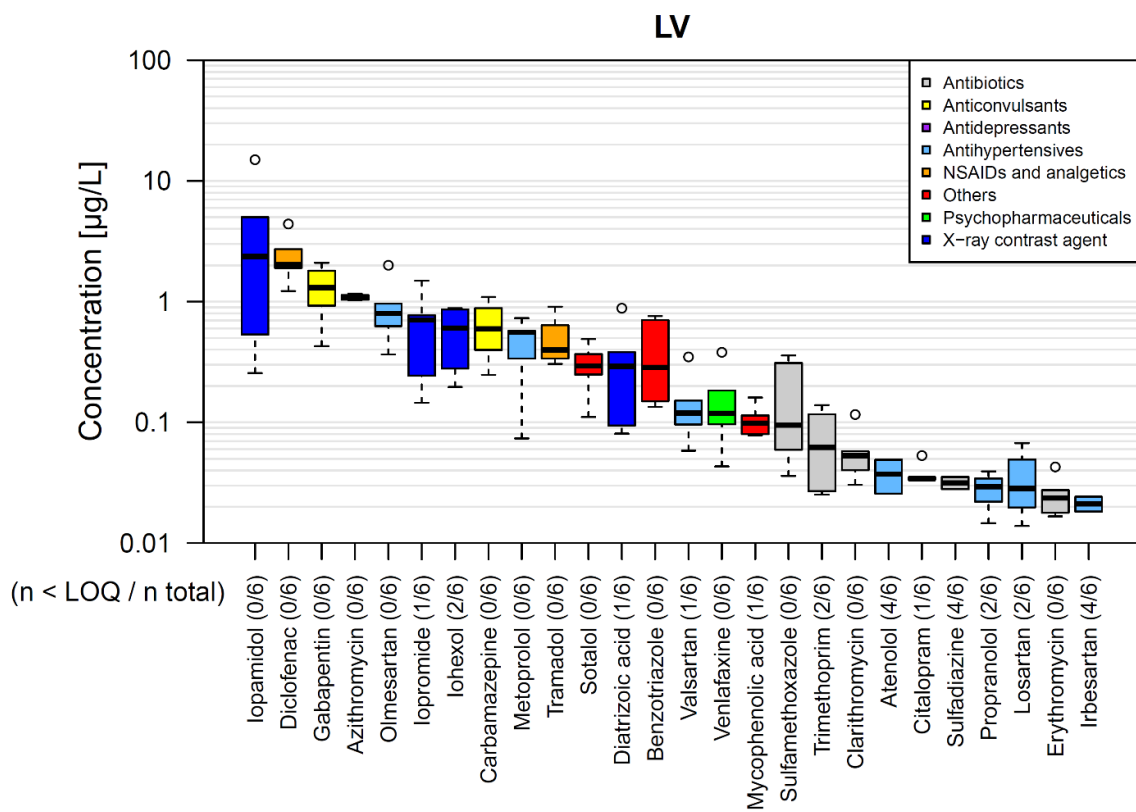
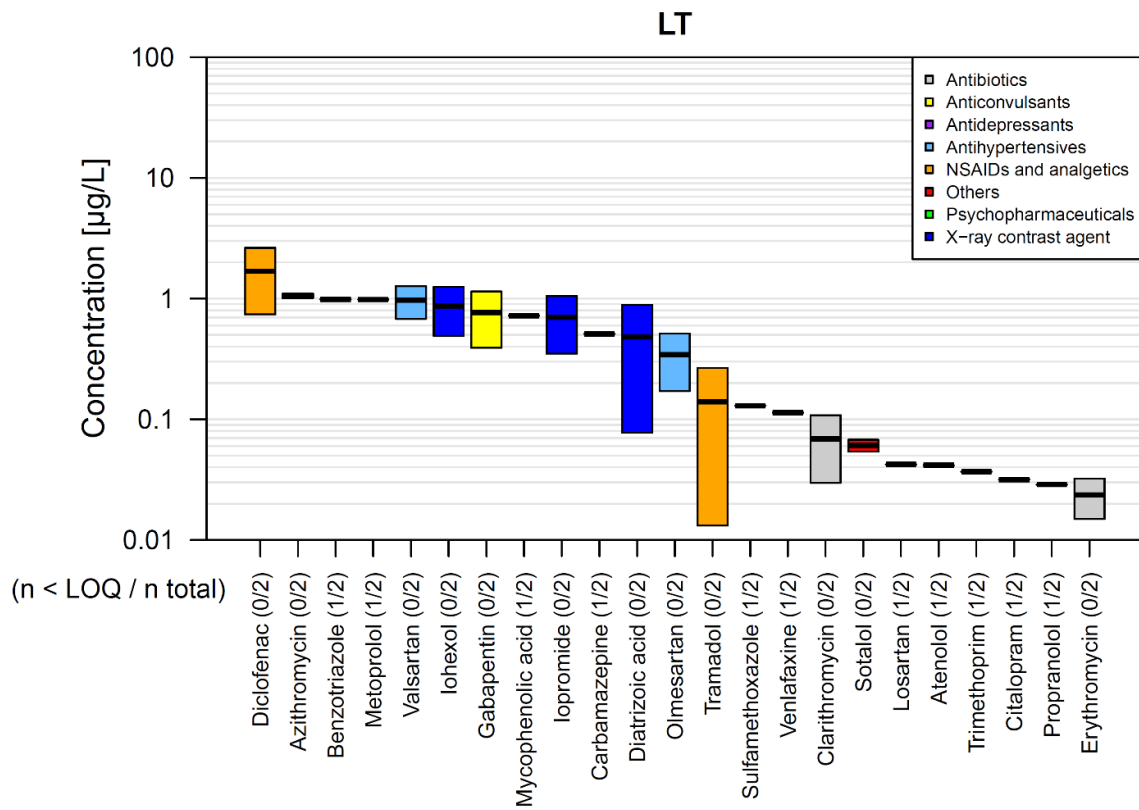

SI-Figure 4: Boxplot of the API concentrations for Lithuania (LT) and Latvia (LV) that have been measured in the wastewater samples. APIs that were below LOQ in all samples are not shown.

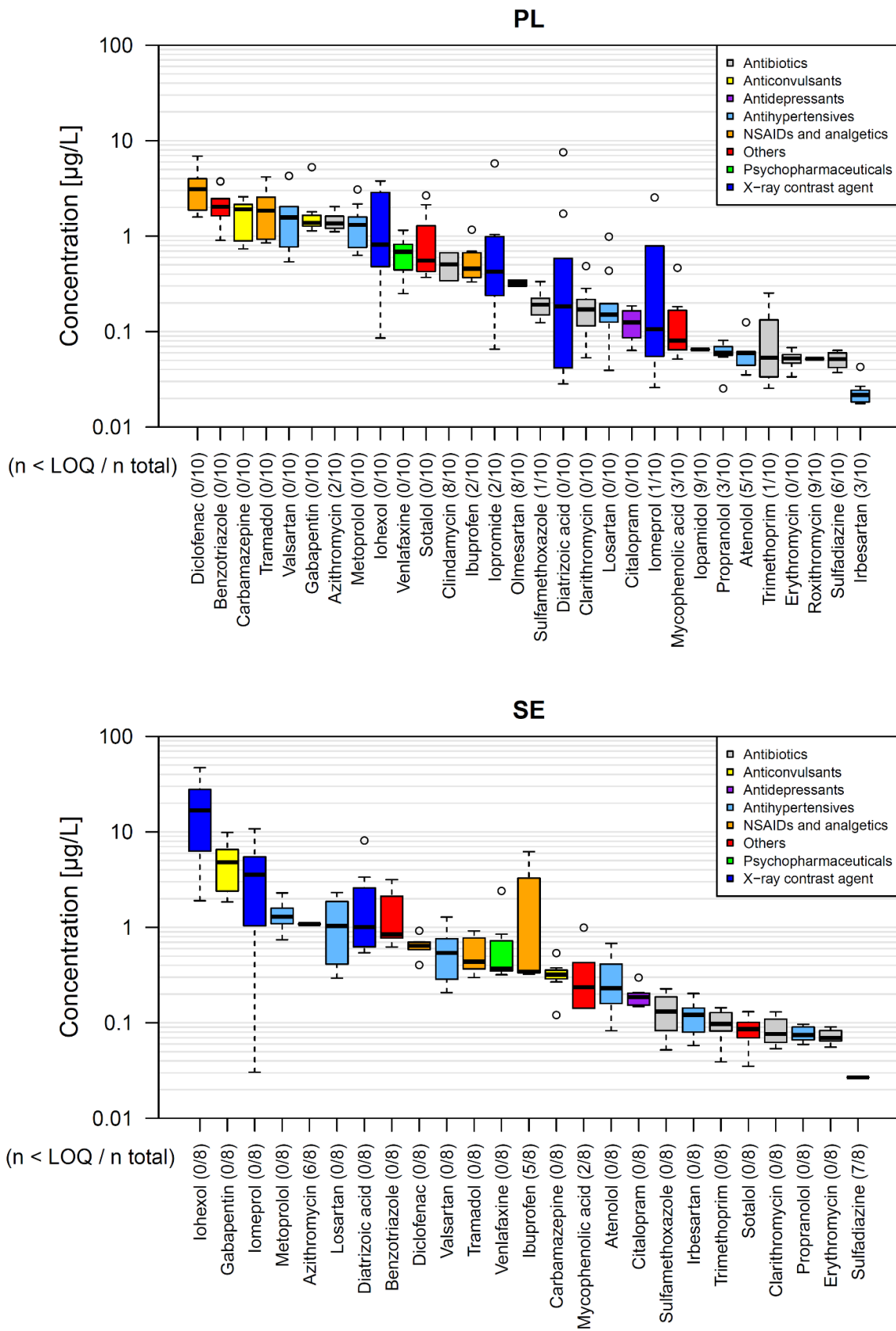

SI-Figure 5: Boxplot of the API concentrations for Poland (PL) and Sweden (SE) that have been measured in the wastewater samples. APIs that were below LOQ in all samples are not shown.

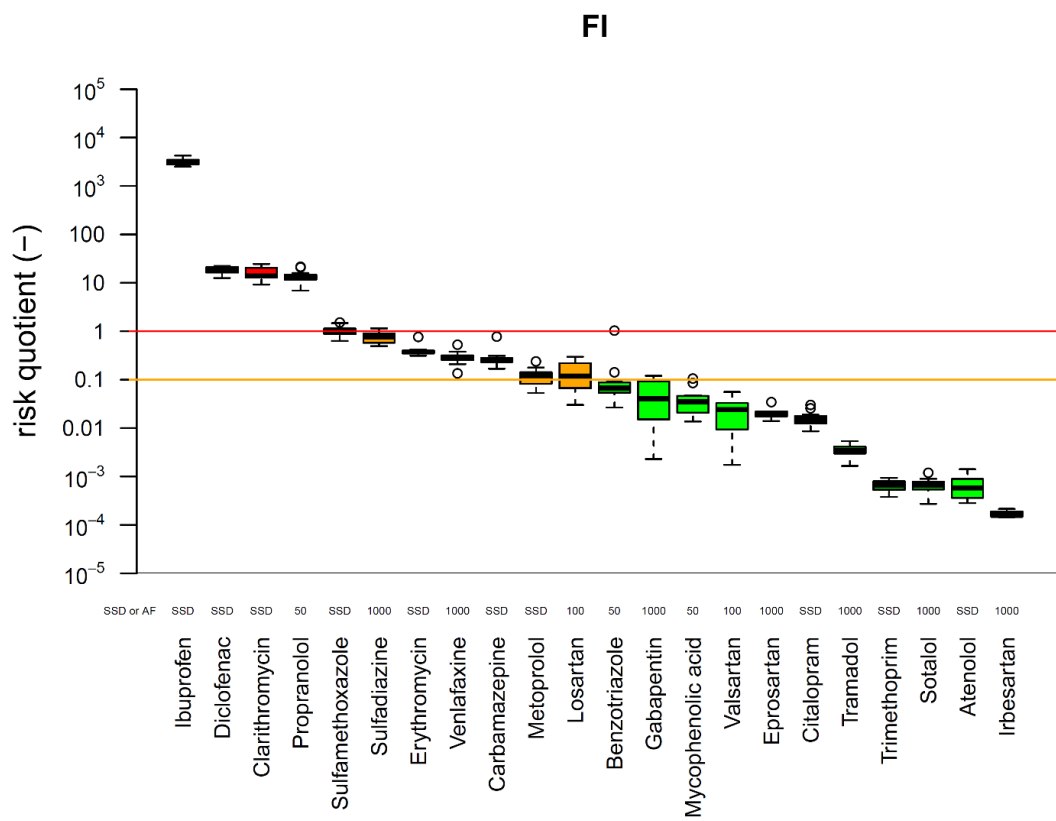
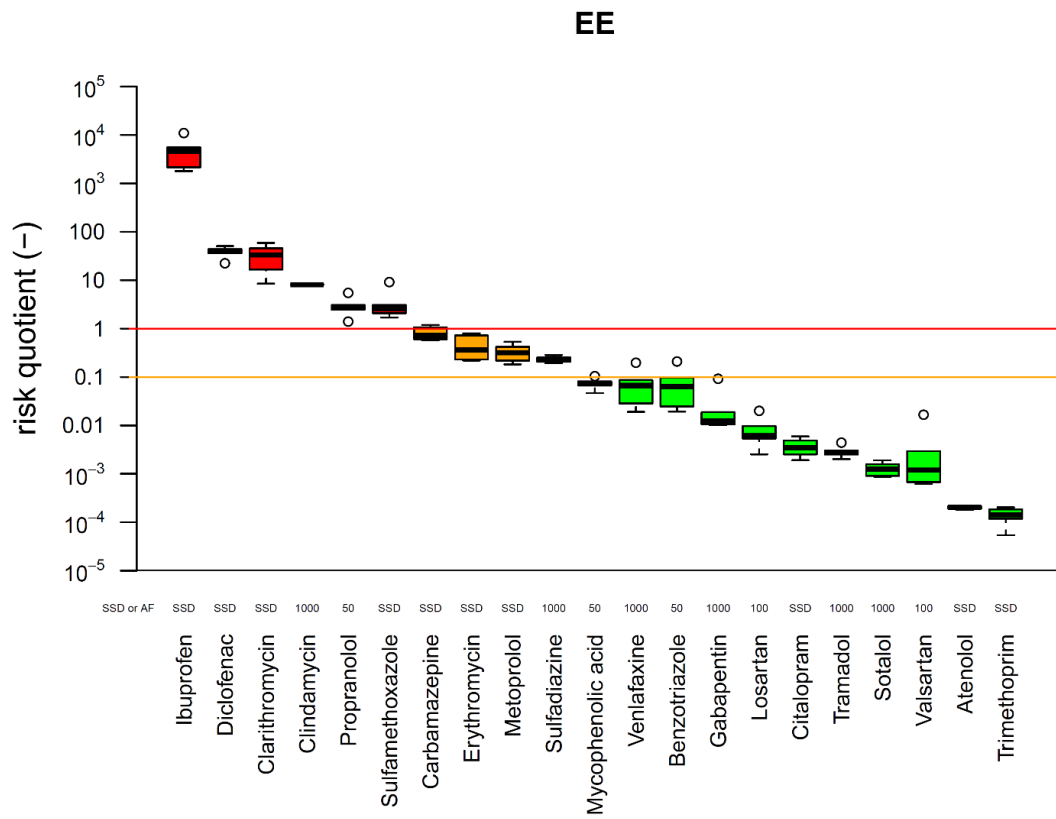

SI-Figure 7: Boxplot of the calculated risk quotients (w/o dilution) for Estonia (EE) and Finland (FI) that are based on the API concentrations in the wastewater samples. APIs for which no PNEC was available or API concentration was below LOQ are not shown.

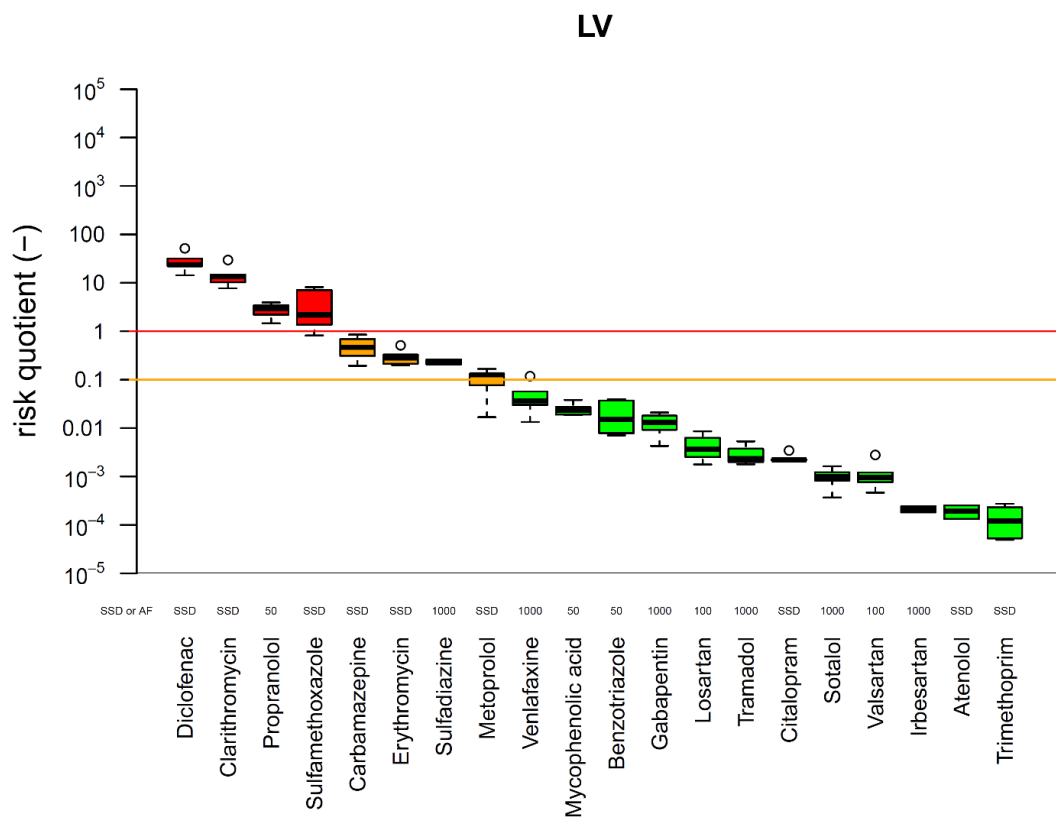
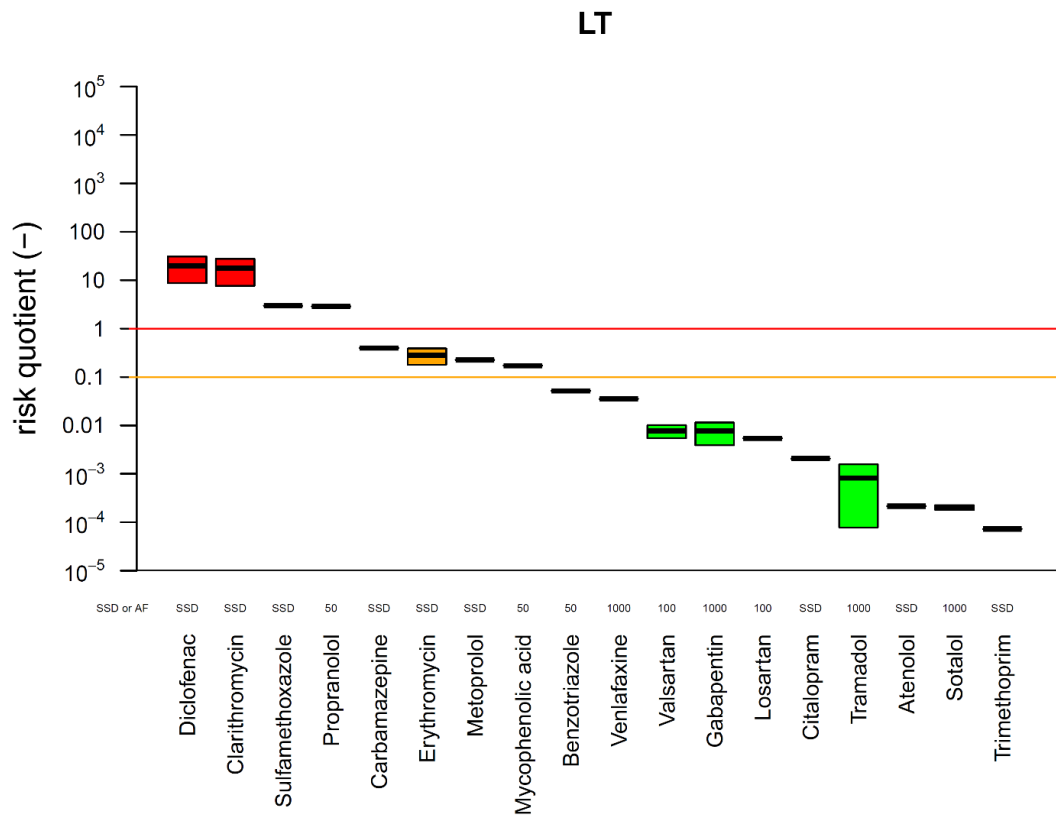

SI-Figure 8: Boxplot of the calculated risk quotients (w/o dilution) for Lithuania (LT) and Latvia (LV) that are based on the API concentrations in the wastewater samples. APIs for which no PNEC was available or API concentration was below LOQ are not shown.

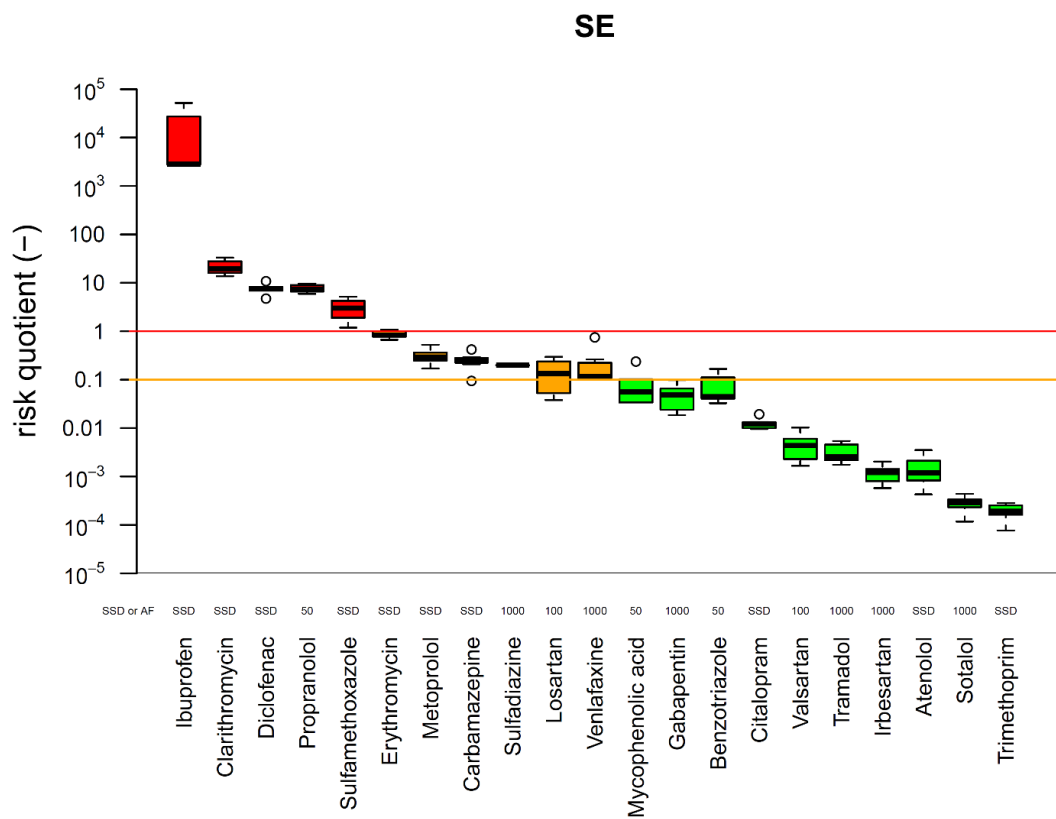
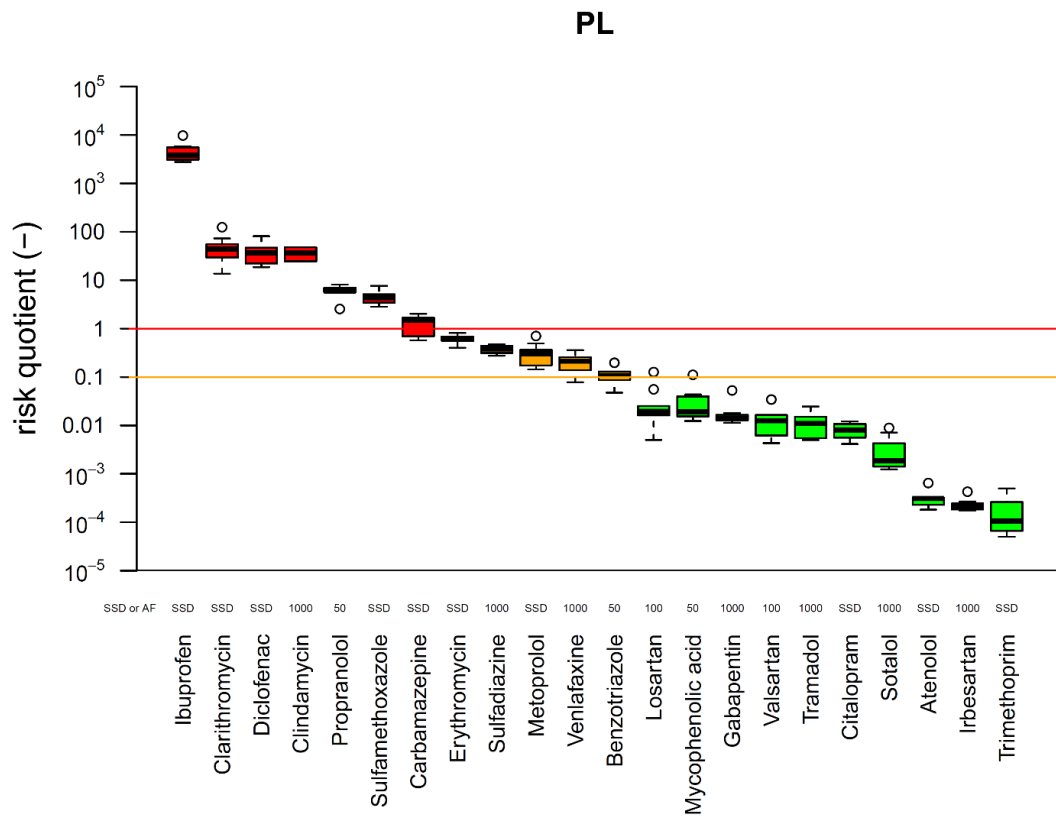

SI-Figure 9: Boxplot of the calculated risk quotients (w/o dilution) for Poland (PL) and Sweden (SE) that are based on the API concentrations in the wastewater samples. APIs for which no PNEC was available or API concentration was below LOQ are not shown.

Appendix F: API overview

SI-Table 1: Overview of the evaluated APIs as well as other substances such as x-ray contrast agents or corrosion inhibitors, which are italicized. If not otherwise stated, PNEC and assessment factors were taken from the CWPharma GoA2.2 report (Ek Henning et al., 2020).

Active pharmaceutical ingredient (API)	PNEC (µg/L)	Assessment factor	CAS Number	Typical API usage
Atenolol (ATE)	194	SSD	29122-68-7	antihypertensive
Azithromycin (AZI)	N/A	N/A	83905-01-5	antibiotic
<i>Benzotriazole (BTZ)</i>	<i>19^a</i>	<i>50^a</i>	<i>95-14-7</i>	<i>corrosion inhibitor, antifreezes</i>
Candesartan (CSC)	0.42	1000	139481-59-7	antihypertensive
Carbamazepine (CBZ)	1.28	SSD	298-46-4	antiepileptic
Ciprofloxacin (CFX)	0.00511	SSD	85721-33-1	antibiotic
Citalopram (CIT)	15.4	SSD	59729-33-8	antidepressant
Clarithromycin (CLM)	0.00391	SSD	81103-11-9	antibiotic
Clindamycin (CDM)	0.014 ^b	1000 ^b	18323-44-9	antibiotic
Diatrizoic acid (DZA)	N/A	N/A	117-96-4	x-ray contrast agent
Diclofenac (DCF)	0.0852	SSD	15307-86-5	analgesic and anti-inflammatory
Eprosartan (ESM)	100	1000	133040-01-4	antihypertensive
Erythromycin (ERY)	0.0835	SSD	114-07-8	antibiotic
Gabapentin (GPN)	100	1000	60142-96-3	antiepileptic
Ibuprofen (IBP)	0.00012	SSD	15687-27-1	analgesic and anti-inflammatory
<i>Iohexol (IHX)</i>	<i>N/A</i>	<i>N/A</i>	<i>66108-95-0</i>	<i>x-ray contrast agent</i>
<i>Iomeprol (IMP)</i>	<i>N/A</i>	<i>N/A</i>	<i>78649-41-9</i>	<i>x-ray contrast agent</i>
<i>Iopamidol (IPD)</i>	<i>N/A</i>	<i>N/A</i>	<i>60166-93-0</i>	<i>x-ray contrast agent</i>
<i>Iopromide (IPR)</i>	<i>N/A</i>	<i>N/A</i>	<i>73334-07-3</i>	<i>x-ray contrast agent</i>
Irbesartan (IBS)	100	1000	138402-11-6	antihypertensive
Losartan (LSP)	7.8	100	114798-26-4	antihypertensive
Metoprolol (MET)	4.38	SSD	51384-51-1	antihypertensive
Mycophenolic acid (MPA)	4.2 ^b	50 ^b	24280-93-1	immunosuppressant
Olmesartan (OLS)	N/A	N/A	144689-63-4	antihypertensive
Oxazepam (OXA)	0.81	100	604-75-1	treatment of anxiety, insomnia, and alcohol withdrawal syndrome
Phenazone (PNZ)	N/A	N/A	60-80-0	anti-inflammatory
Propranolol (PRO)	0.01 ^b	50 ^b	525-66-6	antihypertensive
Roxithromycin (RXM)	N/A	N/A	80214-83-1	antibiotic
Sotalol (SOT)	300	1000	3930-20-9	antiarrhythmic agent
Sulfadiazine (SDZ)	0.135	1000	68-35-9	antibiotic
Sulfamethizole (SMZ)	N/A	N/A	144-82-1	antibiotic
Sulfamethoxazole (SMX)	0.0438	SSD	723-46-6	antibiotic
Tramadol (TRA)	170	1000	27203-92-5	analgesic and anti-inflammatory
Trimethoprim (TRI)	508	SSD	738-70-5	antibiotic
Valsartan (VLS)	125	100	137862-53-4	antihypertensive
Venlafaxine (VLX)	3.22	1000	93413-69-5	antidepressant

PNEC = predicted no effect concentration

SSD = Species Sensitivity Distribution

a) based on European Chemicals Agency (ECHA), date: 14. April 2020. <https://echa.europa.eu/registration-dossier/-/registered-dossier/14234/6/1>

b) based on Ågerstrand, M. Derivation of PNECs for 39 pharmaceutical substances. ACES report number 36. Stockholm University. Table 4.

Appendix G: Directions for reading the boxplots

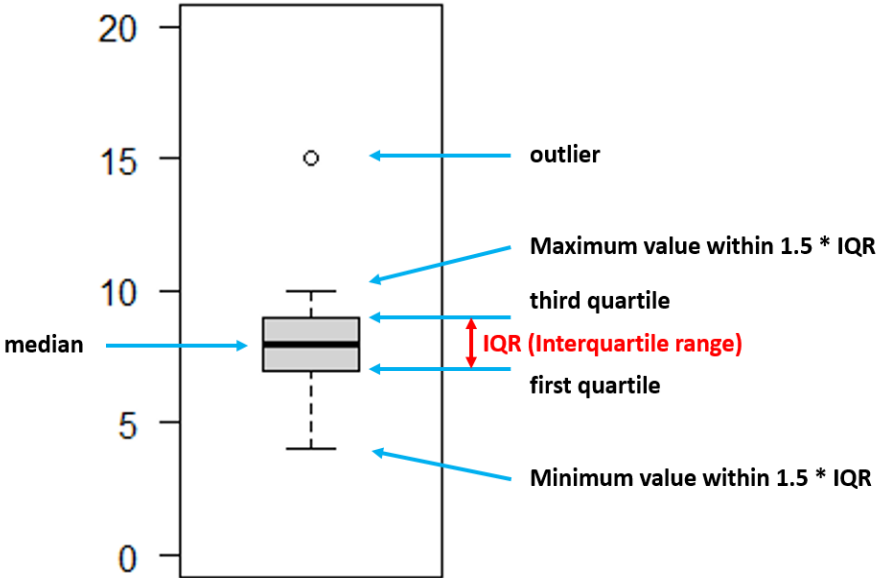

SI-Figure 10: Overview on the different details of the boxplots.